



# ORTHOPEDIC INSTRUMENTS

Orthopedic instruments are used during medical and surgical procedures to manipulate, hold, and support skeletal structures such as the skull, vertebrae, ribs, and long bones. They are commonly used to set or maintain fractures, reduce dislocations, and support tissues during surgery.

[www.warsisurgical.com](http://www.warsisurgical.com)



# COMPANY PROFILE

## General Info

EST. 2010 WARSI SURGICAL INDUSTRIES is a family owned company. We Manufacture and Export all types of general surgical and Orthopedic instruments. We are running this family business in third generation. We have gained excellent reputation among our buyers worldwide with a motto of INSTRUMENT FOR LIFE.

## Contact info

**MUHAMMAD AZEEM**  
(Export & Operational Manager)

+92-306-9774076

info@warsisurgical.com

## Membership

- 1 # THE SURGICAL INSTRUMENTS MANUFACTURERS ASSOCIATION OF PAKISTAN, SIALKOT M # W084
- 2 # THE SIALKOT CHAMBER OF COMMERCE & INDUSTRY, SIALKOT, PAKISTAN, M # A- 25308

## No. of Employees

- 3-EMPLOYEES WORKING ON QCD
- 2- EMPLOYEES WORKING ON MANAGEMENT CONTROL SYSTEM.
- 40 SKILLED WORKING IN DIFFERENT TYPE OF MANUFACTURING UNITS

## Production Cap.

6000/PCS. TO 10000/PCS. MONTHLY PRODUCTION  
IN DIFFERENT OF INSTRUMENTS  
ACCORDING TO THE PRESCRIBED INSTRUCTIONS  
OF QUALITY MANAGEMENT SYSTEMS

## Partners Info



**MUHAMMAD AZAM**  
(Chief Executive)



**MUHAMMAD AZEEM**  
(Export & Operational Manager)



**MUHAMMAD ASIM**  
(Quality Control Manager)



**MUHAMMAD ARIF**  
(Production Manager)



## OUT MOTTO

TO BECOME A GLOBAL GROUP OF COMPANIES BY PROVIDING  
OUR VALUABLE  
CUSTOMERS THE BEST QUALITY PRODUCTS AND PROMPT  
SERVICES THROUGH PRODUCTS  
INNOVATION, DEVELOPMENT AND ACQUISITION OF TECHNOLOGY. SATISFICATION OF  
OUR CUSTOMERS AND EMPLOYEE IS A MAJOR IMPORTANT  
PART OF OUR MISSION.

Warsi Surgical Industries. is a family owned company, dedicated to giving you the personalized service you deserve. We have been supplying the medical industry with the finest in surgical instrumentation for all specialties for over 11 years. From Pakistan, we offer complete service and custom instrument manufacturing in addition to our already broad line of instruments. When you buy from WARSI SURGICAL INDUSTRIES, you are guaranteed the best. Not only the best instruments, but the best service as well. If you ever have a question, we're here to help. We will be happy to give you the support you need.

## Our Mission

Aim to provide products satisfactory for End user needs with accommodation of reliability for life.

## Guarantee

We offer the broadest, highest quality line, reusable surgical instruments. Because of that, our instruments have a lifetime warranty against defects in material or workmanship when used for their intended purpose and when cared for according to industry standards. If you have any questions about use or care please do not hesitate to call us. When you buy from WARSI, you are guaranteed the best instruments and the best service. Just give us a call and find out how much we already know about surgical specialties and your instrument needs!

Muhammad Azam,  
Chief Executive.

## Registration & Membership



## Certifications





# Conversion Table

Multiply	By	To Obtain
Millimeters	0.1	Centimeters
Millimeters	0.03937	Inches
Centimeters	0.3937	Inches
Centimeters	0.01	Meters
Centimeters	10	Millimeters
Inches	2.540	Centimeters
$1/8" = 3.175$ millimeters		
$1/4" = 6.350$ millimeters		
$3/8" = 9.525$ millimeters		
$1/2" = 12.70$ millimeters		
$1" = 25.40$ millimeters		

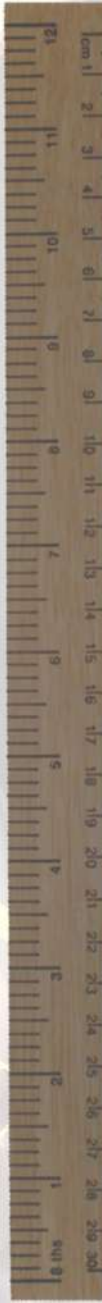
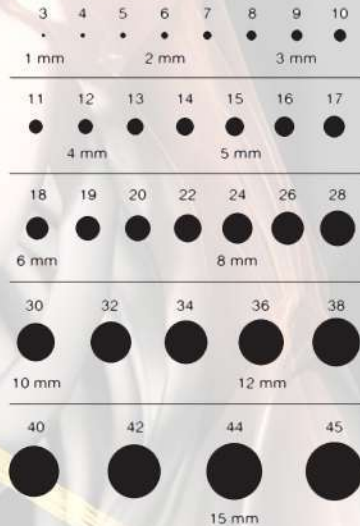



# Introduction To Orthopedic Instruments

Orthopedic instruments are used during medical and surgical procedures to manipulate, hold, and support skeletal structures such as the skull, vertebrae, ribs, and long bones. They are commonly used to set or maintain fractures, reduce dislocations, and support tissues during surgery.

In the Antiquity, surgeons and physicians in Greece and Rome developed many ingenious instruments manufactured from bronze, iron and silver, such as scalpels, lancets, curesets, tweezers, speculae, trephines, forceps, probes, dilators, cures, surgical knives, etc. They are still very well preserved in several medical museums around the world. Most of these instruments continued to be used in Medieval times, albeit with a better manufacturing technique.

The histories behind these eponymous instruments remind us that innovation sometimes begins in other specialties and demonstrate the role of innovation in improving patient care.

Maximize coverage

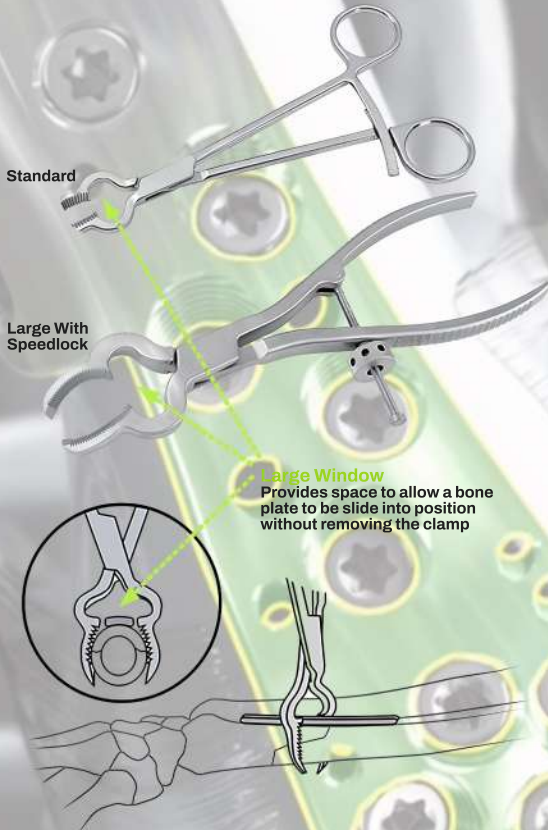

Standard

Large With Speedlock

Large Window  
Provides space to allow a bone plate to be slide into position without removing the clamp



# TABLE OF CONTENT

## (SEC I) ORTHOPEDIC INSTRUMENTS

ORTHOPEDIC ELEVATORS .....	01	ORTHO MAYO SCISSORS .....	249
ORTHOPEDIC CURETTES .....	13	ORTHOPEDIC BONE HOOKS .....	154
ORTHOPEDIC GOUGES .....	39	ORTHOPEDIC RETRACTORS .....	254
ORTHO OSTEOTOMES .....	43	HIPS JOINT INSTRUMENTS .....	260
ORTHO Mallet HAMMER .....	53	ORTHOPEDIC ROUNGERS .....	262
ORTHO MENISCOTOME & KNIFE .....	65	HIPS REVISION INSTRUMENTS .....	267
ORTHOPEDIC PLATE BENDERS .....	68	ORTHOPEDIC CHISELS .....	274
ORTHOPEDIC RETRACTORS .....	73	ORTHOPEDIC SAW .....	276
ORTHOPEDIC SPREADERS .....	107	PIN PULLER & BENDERS .....	280
ORTHO RODE HOLDER & BEND .....	118		
ORTHOPEDIC SCREWDRIVERS .....	124		
ORTHO DRILLS, GUIDE & CHUCK .....	131		
ORTHOPEDIC SPECIALITY .....	144		
ORTHOPEDIC TREPHINES .....	155		
ORTHOPEDIC GRIP PLIERS .....	158		
ORTHOPEDIC WIRE PASSERS .....	162		
ORTHOPEDIC WIRE PIN CUTTER .....	165		
ORTHOPEDIC WIRE TWISTER .....	180		
ORTHOPEDIC RASPS .....	188		
ORTHO ABDOMINAL RETRACTOR .....	207		
ORTHO METZENBAUM SCISSORS .....	215		
BANDAGE & SUTURE SCISSORS .....	236		

## (SEC II) BONE HOLDING

BONE HOLDING CLAMPS .....	01
BONE REDUCTION CLAMPS .....	18
BONE CARTILAGE CLMAPS .....	36



# ORTHOPEDIC ELEVATORS

• **Farabeuf Rugine Elevator**

• **16cm/6¼" length With Hollow Handle**

- SP-11-6
- Straight
- 12mm
- SP-12-6
- Curved\*
- 12mm

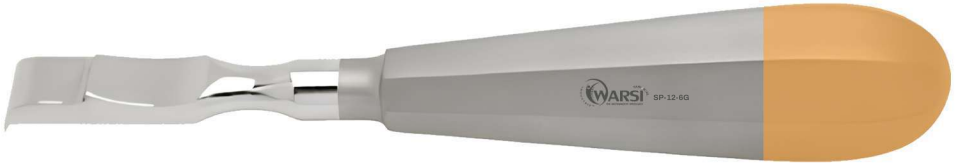

SP-12-6G

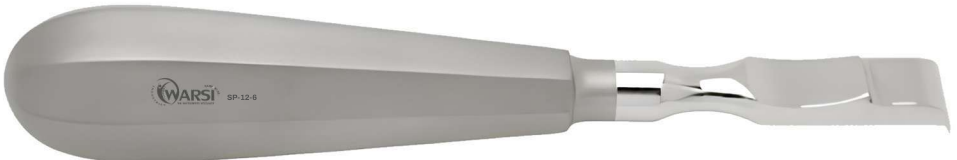

SP-12-6

• **Freer Periosteal Elevator**

• **Double-ended / round handle / curved / 3.5 mm tip / sharp / 7 1/4" / 1100-8-H**

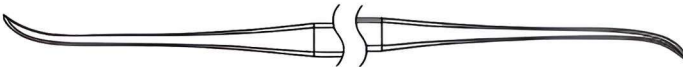
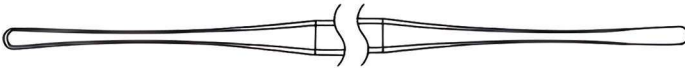

## McGlamry Metatarsal Elevator

• 17cm/6½"

Sharp

WO-378-7 19mm

WO-378-8 11mm

WO-378-9 13mm

WO-378-10 15mm

WO-378-11 19mm



## Murphy Bone Skid Elevator

• Murphy Bone Skid Elevator

23cm/9" length

For dislocation of the femoral head

Double ended

WO-378-12

WO-378-13



• Murphy Bone Skid Elevator  
23cm/9" length  
For dislocation of the femoral head  
Double ended  
WO-378-14

• **Mini Bone Lever**

- 14cm/5½"  
| 2.8mm width  
WO-378-15



WO-378-15

• **Hohmann Style Mini-Bone Lever**

- 16cm/6¼"  
| 6mm width  
WO-378-16



WO-378-16

• **Phalangeal Lever**

- 15cm/6"  
| 5mm width  
WO-378-17



WO-378-17

• **Buck-Gramcko Lever**

- 15cm/6"  
| 7.5mm width  
WO-378-18



WO-378-18

• **Mini-Cobra Bone Lever**

- 16cm/6¼"  
| 15mm width  
WO-378-19



WO-378-19

• **Warsi A O Type Elevator / Raspatory**

- Phenolic handles / 8" (20 cm)
- WS-333-20 13 mm tip angled flat edge
- WS-333-25 14 mm tip str round edge
- WS-333-20 14 mm tip cvd round edge
- WS-333-28 20 mm tip str round edge

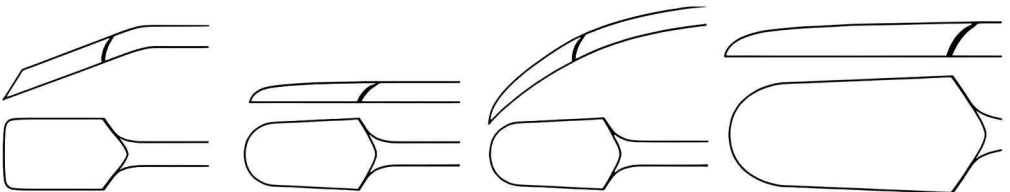

• **WarsiA O Type Elevator / Raspatory**

- Phenolic handles / 7 1/2" (19 cm)
- WS-335-50 6 mm tip str flat edge
- WS-335-54 3 mm tip slight curve round edge
- WS-335-55 3 mm tip slight curve flat edge
- WS-335-60 6 mm tip slight curve flat edge
- WS-335-65 6 mm tip slight curve round edge

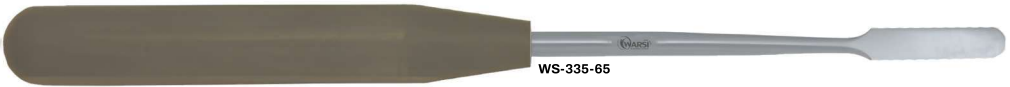
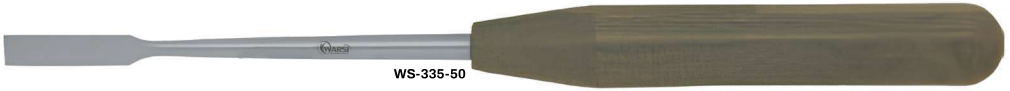

• **Adson Periosteal Elevator**

- Single-ended / 6 1/2" (16.5 cm)
- WS-412-20 str chisel edge
- WS-412-22 cvd blunt
- WS-412-24 cvd semi-sharp
- WS-412-26 str semi-sharp



WS-412-24



WS-412-22



WS-412-26

• **Love Adson Periosteal Elevator**

- 26cm/10" length
- SP-331-6



SP-331-6

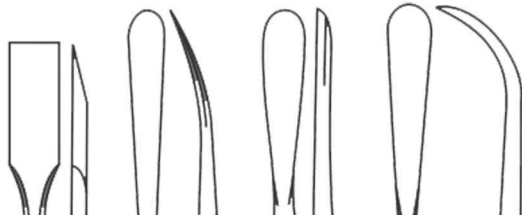

• **Adson Periosteal Elevator**

- 16cm/6¼" length
- Curved / blunt
- 5mm-7mm
- SP-35-16
- SP-37-16

SP-37-16



• **Pennybacker Periosteal Elevator**

- 16cm/6¼" length
- Curved sharp
- 4mm-6mm-8mm
- SP-34-16
- SP-36-16
- SP-38-16

SP-36-16



• **Bone Raspatory with Tufnol Handle**

- 19cm/7½" length
- Straight / Curved



HA-716-19  
Straight  
6mm

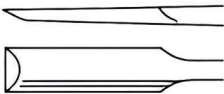

HA-723-19  
HA-726-19  
Curved  
3mm-6mm

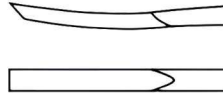

• **Farabeuf Rugine Elevator**

- 15cm/6" length
- SP-301-15
- Straight
- 12mm
- SP302-15
- Curved\*
- 12mm

SP-301-15



Illustrated\*

● **Long Curved Hohmann Inferior Hip Elevator**

- 40cm/16" length
- 22mm width
- WO-378-20



● **Modified Hohmann Elevator**

- 90° angled
- Width
- WO-378-21 10mm
- WO-378-22 18mm
- WO-378-23 25mm
- WO-378-24 43mm
- WO-378-25 70mm



● **Modified Cobra Aufrang Elevator**

- 33cm/13" long blade
- 30mm x 100mm
- WO-378-26



● **Shallow Bone Elevator**

- 25cm/9¾" length
- WO-378-27



● **Concave Moor Elevator**

- 33cm/13" long blade
- WO-378-28



• **Fagge Bone Elevator**

- 27.5cm/10¾" length  
SP3032-27



• **Bristow Periosteal Elevator**

- 23cm/9" length  
Curved sharp  
10mm width  
SP3003-23



• **Femoral Dislocation Lever**

- 31cm/12½" length  
26mm width  
SP3026-31



• **Muller Femoral Retractor**

- 35cm/13½" length  
28mm width  
SP3028-35



For retraction of the femoral neck.

• **Freer Periosteal Elevator**

- Double-ended / round handle / curved / sharp/blunt / 7 1/2"
- WS-11-78B 5 mm tip
- WS-11-78C 6.7 mm tip



WS-11-78B

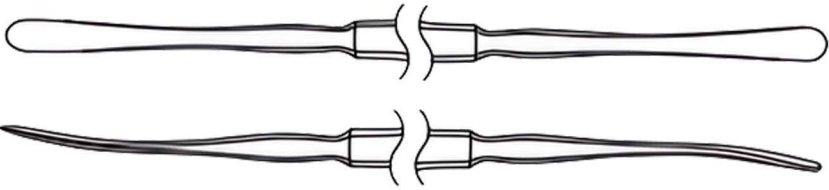

WS-11-78C

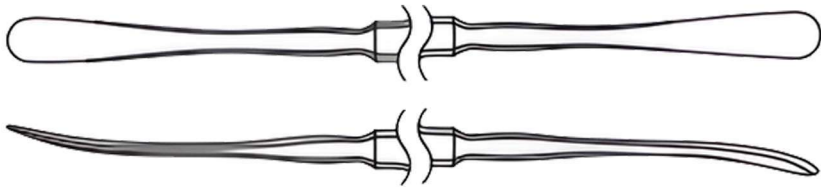

- Double-ended / knurled round handle / curved / 4.5 mm tip / sharp/blunt / 6 3/4"
- WS-11-79D

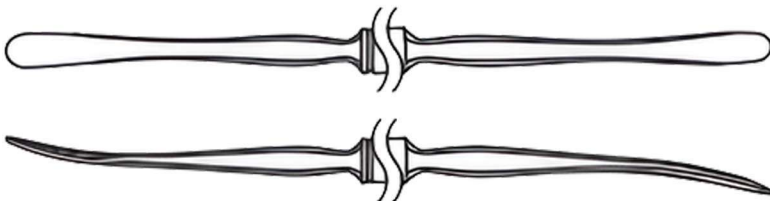

• **Freer Periosteal Elevator**

- Double-ended / square handle / straight / 4.5 mm tip / sharp/blunt / 7 3/4" / 110-78-S

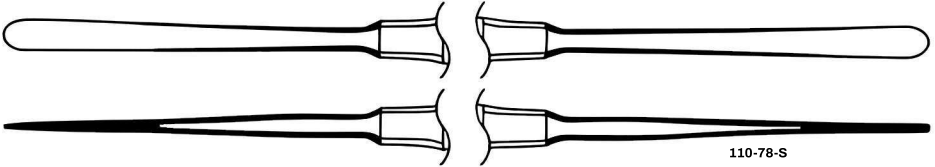

- Double-ended / square handle / curved / 4.5 mm tip / sharp/blunt / 110-79 7 3/4" / 110-79F 8 3/4"

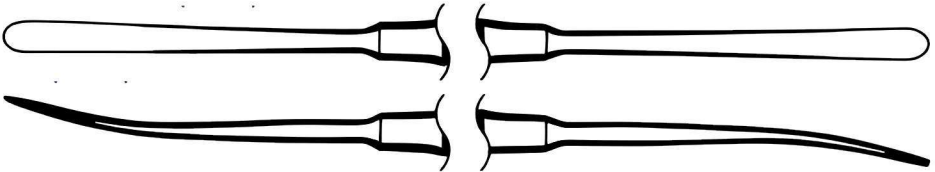

- Double-ended / square handle / curved / 4.5 mm tip / sharp/blunt / 110-799 7 3/4" / 110-799F 8 3/4"

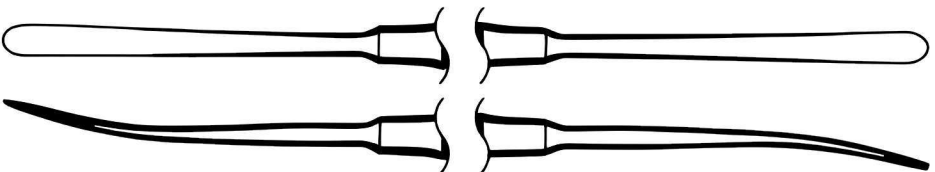

● **Hohmann Bone Elevator**

- 22cm/8½" length  
8mm width  
WO-378-1



- 24cm/9½" length  
18mm width  
WO-378-2



- 24.5cm/9½" length  
43mm width  
WO-378-3



- 24cm/9½" length  
70mm width  
WO-378-4



- 28cm/11" length  
33mm width  
WO-378-5



- 26cm/10" length  
24mm width  
WO-378-6





# ORTHOPEDIC CURETTES



• **Lampert Curette**

• **Thin neck / oval cup / straight / 8" (20.5 cm)**

- WC-20-26T size 000000
- WC-20-27T size 00000
- WC-20-29T size 0000
- WC-20-30T size 000
- WC-20-31T size 00
- WC-20-32T size 0
- WC-20-33T size 1
- WC-20-34T size 2

WC-20-29T



• **Thin neck / oval cup / angled / 8" (20.5 cm)**

- WC-20-47T size 000000
- WC-20-48T size 00000
- WC-20-49T size 0000
- WC-20-50T size 000
- WC-20-51T size 00
- WC-20-52T size 0
- WC-20-53T size 1
- WC-20-54T size 2

WC-20-52T



• **Bayonet Curette Titanium**

• **Bending Hypophysis Enucleator / 8 3/4" (22 cm)**

- WC-43-00

WC-43-00



• **Bayonet Ring Curette Titanium**

• **8 3/4" (22.2 cm)**

- WC-43-60 2.5 mm 45° up angle
- WC-43-61 3.0 mm 45° up angle
- WC-43-62 2.5 mm 40° down angle
- WC-43-63 3.0 mm 40° down angle
- WC-43-64 2.5 mm 90° up angle
- WC-43-65 3.0 mm 90° up angle

• **10 1/4" (25.26 cm)**

- WC-43-50 3.0 mm 90° up angle
- WC-43-51 3.0 mm 90° down angle
- WC-43-52 2.25 mm 45° up angle

• **11" (28 cm)**

- WC-413-55 3.0 mm 90° up angle
- WC-413-57 3.0 mm 40° down angle
- WC-413-58 2.25 mm 45° up angle

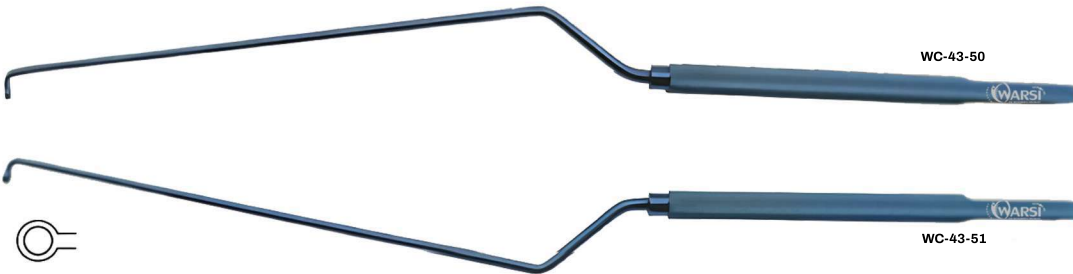

• **Neuro Ring Curette**

• **Titanium / 8 1/4" (21 cm) / straight**

- WC-43-44 2 mm
- WC-43-45 3 mm



• **Down Pushing Curette**

- Phenolic handle / 10 mm x 5 mm / 9" handle / 15" (38 cm) / 380 mm

WC-330-79



WC-330-79

• **O'Brien Curette**

- Phenolic handle / 9" handle / 15" (38 cm)

WC-330-94A 8mm

WC-330-94B 11 mm



WC-330-94B

• **Charnley Curette**

- Phenolic handle / 9" handle / 15" (38 cm) / 380 mm

WC-330-89L large

WC-330-89S small



WC-330-89S

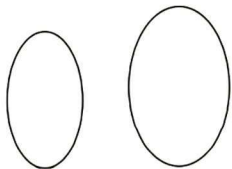

• **Tear Drop Spinal Curette**

- **Phenolic handle / 52 mm x 12 mm / 11" (27.9 cm)**

WC-30-958 straight  
WC-30-959 angled 15°

- **Phenolic handle / 52 mm x 12 mm / 17" (43.2 cm)**

WC-20-960 straight  
WC-20-962 angled 15°

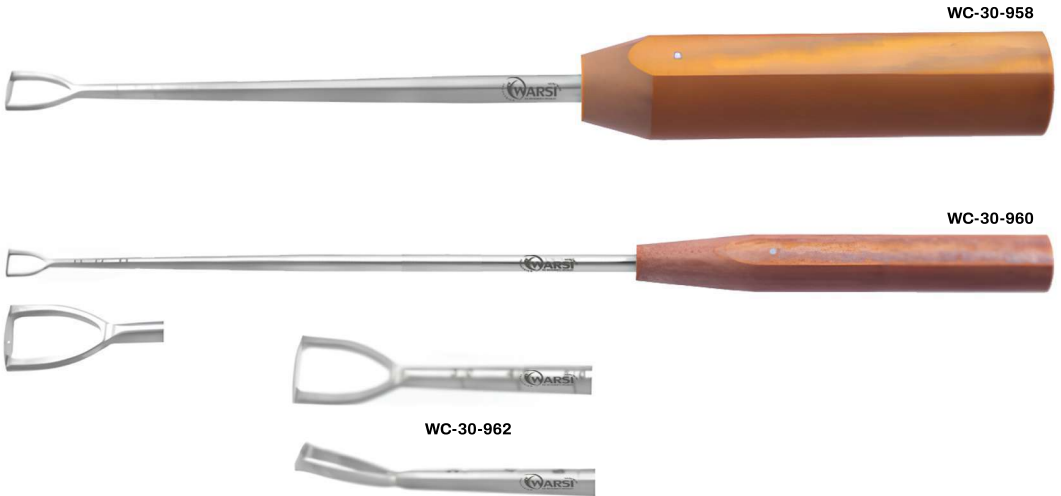

• **Spinal Curette**

• **Phenolic handle / straight**

/ 11" (28 cm)

- WC-32-866 size 000
- WC-32-859 size 00
- WC-32-860 size 0
- WC-32-861 size 1
- WC-32-862 size 2
- WC-32-863 size 3
- WC-32-864 size 4
- WC-32-865 size 5



• **Phenolic handle / angled**

/ 11" (28 cm)

- WC-32-866A size 000
- WC-32-859A size 00
- WC-32-860A size 0
- WC-32-861A size 1
- WC-32-862A size 2
- WC-32-863A size 3
- WC-32-864A size 4
- WC-32-865A size 5

• **Extra Long Spinal Curette**

• **Phenolic handle / extra long / angled / 13" (33 cm)**

WC-32-920 size 0



• **USA Curette**

• **Phenolic handle / oval cup  
/ 5" handle / 11" (28 cm)**

- WC-32-687 size 5/0
- WC-32-686 size 4/0
- WC-32-678 size 3/0
- WC-32-679 size 2/0
- WC-32-680 size 0
- WC-32-681 size 1
- WC-32-682 size 2
- WC-32-683 size 3
- WC-32-684 size 4
- WC-32-685 size 5



WC-32-683

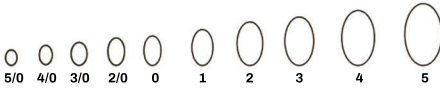

• **USA Ring Curette**

• **Phenolic handle / straight /  
5" handle / 10" (25.5 cm) /  
250 mm**

- WC-32-922A size 2
- WC-32-922B size 3
- WC-32-922C size 4

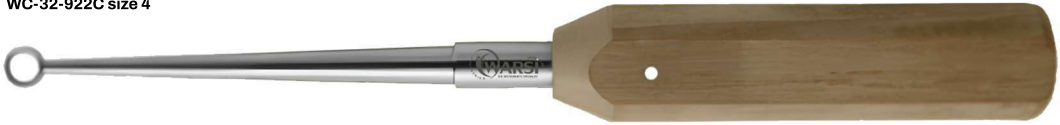

WC-32-922B



WC-32-922C

**Phenolic handle / angled /  
5" handle / 10" (25.5 cm) /  
250 mm**

- WC-32-923A size 2
- WC-32-932B size 3
- WC-32-923C size 4

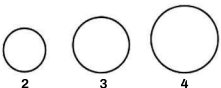

• **Cone Ring Two Handed Curette**

• **Phenolic handle / straight / 15" (38 cm) / 380 mm**

- WC-32-881A size 1
- WC-32-881B size 2
- WC-32-881C size 3
- WC-32-881D size 4



WC-32-881C

• **Phenolic handle / angled / 15" (38 cm) / 380 mm**

- WC-32-882A size 1
- WC-32-882B size 2
- WC-32-882C size 3
- WC-32-882D size 4

• **Phenolic handle / lateral angled / 15" (38 cm) / 380 mm**

- WC-32-883A size 1
- WC-32-883B size 2
- WC-32-883C size 3
- WC-32-883D size 4



WC-32-883C

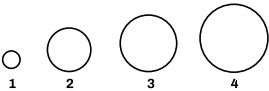

- **Cone Ring Two Handed Curette**
- **Phenolic handle / 9mm / 14 1/2" (37 cm) / 370 mm**  
WC-30-615 straight  
WC-30-617 40° lateral



- **Black handle / 9mm / 14 1/2" (37 cm) / 370 mm**  
WC-30-615B straight  
WC-30-617B 40° lateral



• **Two Handed Curette**

- **Phenolic handle / serrated cup**  
/ 6mm x 9mm / 14 1/2" (37 cm)

WC-30-621 straight  
 WC-30-622 30d up  
 WC-30-623 45d cvd left  
 WC-30-624 45d cvd right  
 WC-30-625 90d



WC-30-621

- **Black handle / serrated cup / 6 mm x 9 mm / 14 1/2" (37 cm)**

WC-30-621B straight  
 WC-30-622B 30d up  
 WC-30-623B 45d cvd left  
 WC-30-624B 45d cvd right  
 WC-30-625B 90d

\* Available in a green handle



WC-30-621B



straight



30d up



45d curved left



45d curved right



90d

**Two Handed Curette**

**Black handle / 90° / 18" (45.7 cm)**

- WC-30-584 2 mm
- WC-30-585 3.8 mm
- WC-30-586 8 mm

**Black handle / 30° / 18" (45.7 cm)**

- WC-30-580 2 mm
- WC-30-581 2.8 mm
- WC-30-582 4 mm oval
- WC-30-583 7 mm

**Black handle / straight / 18" (45.7 cm)**

- WC-30-587 3 mm
- WC-30-588 7 mm

**Tear Drop Curette**

**Black handle / 11 mm teardrop / 18" (45.7 cm)**

- WC-30-589 straight
- WC-30-590 15 degree angled



• **Long Handle Curette**

• **Sharp / black handle / 16 1/2" (41.9 cm)**

- WC-30-626B teardrop
- WC-30-629B #3 angled
- WC-30-630B #6 angled

• **Sharp / green handle / 16 1/2" (41.9 cm)**

- WC-30-626G teardrop
- WC-30-629G #3 angled
- WC-30-630G #6 angled



WC-30-626G



WC-30-626B



WC-30-629G



WC-30-630G



WC-30-626G



WC-30-626B

• **Two Handed Large Grip Curette**

• **Phenolic handle / oval cup / straight / 7" handle**

/ 13" (33 cm)

WC-30-658 size 3/0

WC-30-659 size 2/0

WC-30-660 size 0

WC-30-661 size 1

WC-30-662 size 2

WC-30-663 size 3

WC-30-664 size 4

WC-30-665 size 5

WC-30-666 size 6

WC-30-667 size 7

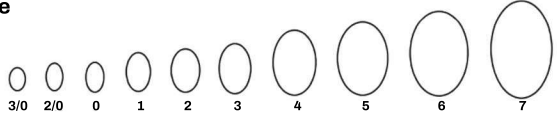

WC-30-663

• **Phenolic handle / oval cup / straight / 7" handle**

/ 13" (33 cm)

WC-30-658 size 3/0

WC-30-659 size 2/0

WC-30-660 size 0

WC-30-661 size 1

WC30-662 size 2

WC-30-663 size 3

WC-30-664 size 4

WC-30-665 size 5

WC-30-666 size 6

WC-30-667 size 7



WC-30-643

• **Phenolic handle / oval cup / straight / 7 1/2"**

handle / 16" (40.5 cm)

WC-30-670 size 5



• **Phenolic handle / oval cup / with teeth / 9"**

handle / 15" (38 cm) / 380 mm

WC-30-634T size 4

WC-30-636T size 6



WC-30-636T



• **Two Handed Large Grip Curette**

• **Phenolic handle / straight / 4.5" handle /**

- 9.5" (24 cm) / 240 mm
- WC-30-889A size 6/0
- WC-30-889B size 5/0
- WC-30-889C size 4/0
- WC-30-889D size 3/0
- WC-30-889E size 2/0
- WC-30-889F size 0



WC-30-889F

• **Phenolic handle / angled / 4.5" handle / 9.5"**

- (24 cm) / 240 mm
- WC-30-888A size 6/0
- WC-30-888B size 5/0
- WC-30-888C size 4/0
- WC-30-888D size 3/0
- WC-30-888E size 2/0
- WC-30-888F size 0

• **Phenolic handle / rev. angled / 4.5" handle /**

- 9.5" (24 cm) / 240 mm
- WC-30-887A size 6/0
- WC-30-887B size 5/0
- WC-30-887C size 4/0
- WC-30-887D size 3/0
- WC-30-887E size 2/0
- WC-320-887F size 0

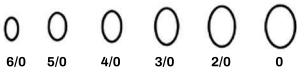

• **Two Handed Large Grip Curette**

- **Phenolic handle / straight / 4.5" handle / 9.5" (24 cm) / 240 mm**

WC-30-886A size 6/0  
 WC-30-886B size 5/0  
 WC-30-886C size 4/0  
 WC-30-886D size 3/0  
 WC-30-886E size 2/0  
 WC-30-886F size 0



**Phenolic handle / angled / 4.5" handle / 9.5" (24 cm) / 240 mm**

WC-30-885A size 6/0  
 WC-30-885B size 5/0  
 WC-30-885C size 4/0  
 WC-30-885D size 3/0  
 WC-30-885E size 2/0  
 WC-30-885F size 0

WC-30-886E

**Phenolic handle / rev. angled / 4.5" handle / 9.5" (24 cm) / 240 mm**

WC-30-884A size 6/0  
 WC-30-884B size 5/0  
 WC-30-884C size 4/0  
 WC-30-884D size 3/0  
 WC-30-884E size 2/0  
 WC-30-884F size 0

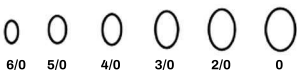

• **Micro Axial Bayonet Long Curette**

• **Phenolic handle / long shaft / straight / bayonet / 5" handle / 12" (32 cm)**

- WC-30-803A 1 mm
- WC-30-803B 2 mm
- WC-30-803C 3 mm
- WC-30-803D 4 mm
- WC-30-803E 5 mm
- WC-30-803F 6 mm

**Phenolic handle / long shaft / angled / bayonet / 5" handle / 12" (32 cm)**

- WC-30-804A 1 mm
- WC-30-804B 2 mm
- WC-30-804C 3 mm
- WC-30-804D 4 mm
- WC-30-804E 5 mm
- WC-30-804F 6 mm

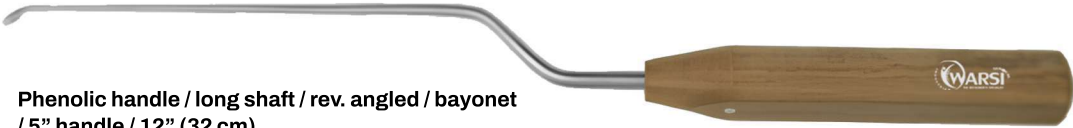

**Phenolic handle / long shaft / rev. angled / bayonet / 5" handle / 12" (32 cm)**

- WC-30-805A 1 mm
- WC-30-805B 2 mm
- WC-30-805C 3 mm
- WC-30-805D 4 mm
- WC-30-805E 5 mm
- WC-30-805F 6 mm

WC-30-804C



WC-30-805B

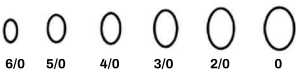

• **Micro Axial Bayonet Extra Long Curette**

• **Phenolic handle / long shaft / straight / bayonet / 5" handle /**

- 14" (35.5 cm)**  
 WC-30-800A 1 mm  
 WC-30-800B 2 mm  
 WC-30-800C 3 mm  
 WC-30-800D 4 mm  
 WC-30-800E 5 mm  
 WC-30-800F 6 mm

**Phenolic handle / long shaft / angled / bayonet / 5" handle /**

- 14" (35.5 cm)**  
 WC-30-801A 1 mm  
 WC-30-801B 2 mm  
 WC-30-801C 3 mm  
 WC-30-801D 4 mm  
 WC-30-801E 5 mm  
 WC-30-801F 6 mm



**Phenolic handle / long shaft / rev. angled / bayonet / 5" handle / 14" (35.5 cm)**

- WC-30-802A 1 mm  
 WC-30-802B 2 mm  
 WC-30-802C 3 mm  
 WC-30-802D 4 mm  
 WC-30-802E 5 mm  
 WC-30-802F 6 mm

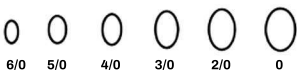

• **Spinal Fusion Curette**

• **Oval cup / 9" (23 cm)**

- WC-320-866-9-01 straight size 000
- WC-320-866-9-0110 straight size 00
- WC-320-860-9-0 straight size 0
- WC-320-861-9-1 straight size 1
- WC-320-862-9-2 angled size 2
- WC-320-863-9-3 straight size 3
- WC-320-864-9-4 angled size 4
- WC-320-865-9-5 straight size 5
- WC-320-867-9-6 angled size

WC-320-866-9-3



WC-320-866-9-01

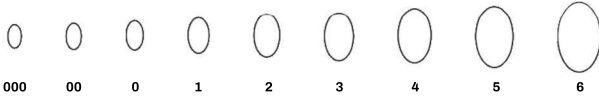

• **Anterior Spinal Curette**

• **Hollow knurled handle / oval cup / straight / 15" (38 cm)**

- WC-30-868-15-00 straight size 00
- WC-30-868-15-1 straight size 1
- WC-30-868B-15-6 bayonet size 6

WC-30-868-15-00



WC-30-868-15-1



● **Cobb Spinal Curette**

● **Hollow knurled handle / oval cup / straight / 11" (28 cm)**

- WC-30-896 size 000
- WC-30-87 size 00
- WC-30-88 size 0
- WC-30-89 size 1
- WC-30-90 size 2
- WC-30-91 size 3
- WC-30-92 size 4
- WC-30-93 size 5
- WC-30-94 size 6



● **Hollow knurled handle / oval cup / angled / 11" (28 cm)**

- WC-30-910 size 000
- WC-30-11 size 00
- WC-30-12 size 0
- WC-30-13 size 1
- WC-30-14 size 2
- WC-30-15 size 3
- WC-30-16 size 4
- WC-30-17 size 5
- WC-30-18 size 6

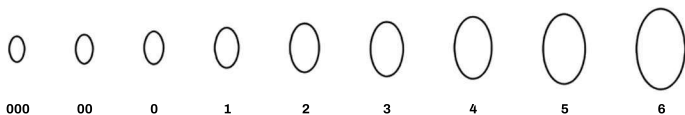

• **Volkman Curette**

- 22cm/8¾" length  
Double ended

RC-30-868



RC-30-868

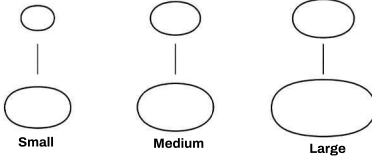

• **Muller Bone Curette**

- 27cm/9¾" length  
Tufnol handle

RC-30-868



\*illustrated

RC-30-869



Small cup 9mm Ø



Medium cup 13mm Ø\*



Large cup 27mm Ø

• **Charnley Bone Curette**

- 37cm/15" length  
T-handle

RC-30-870



\*illustrated

RC-30-870



Small cup 14mm Ø



Medium cup 17mm Ø



Large cup 22mm Ø\*

• **Stille Curette**

• **Flat handle / round cup / Gold**

- WC-103-63 2 mm 6 1/2"
- WC-103-64 3 mm 6 1/2"
- WC-103-65 4 mm 6 1/2"
- WC-103-66 5 mm 7 3/4"
- WC-103-67 6 mm 7 3/4"
- WC-103-68 7 mm 7 3/4"
- WC-103-69 8 mm 7 3/4"
- WC-103-70 10 mm 8"
- WC-103-71 12 mm 8"
- WC-103-72 14 mm

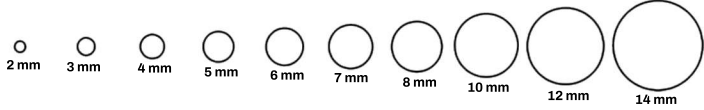

WC-103-66



WC-103-63

• **Bruns Round Cup Curette**

• **Round cup / straight / 6 3/4" (17 cm)**

- WC-320-78 size 00000
- WC-320-79 size 0000
- WC-320-70 size 000
- WC-320-71 size 00
- WC-320-72 size 0
- WC-320-73 size 1
- WC-320-74 size 2
- WC-320-75 size 3
- WC-320-76 size 4
- WC-320-77 size 5
- WC-320-78 size 6

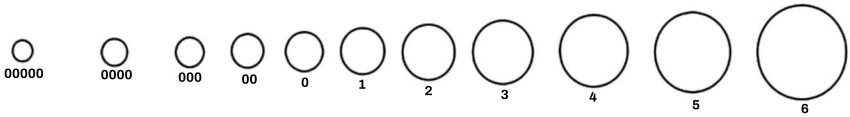

WC-320-77



WC-320-78

• **Cone Ring Curette**

• **Aluminum handle / inside ring diameter / 9" (23 cm)**

- WC32-52 3mm straight
- WC32-55 3mm angle
- WC32-51 6mm straight
- WC32-54 6mm angle
- WC32-50 8mm straight
- WC32-53 8mm angle



WC32-54

• **Hatt Spoon Curette**

• **Solid hexagonal handle / 9" (23 cm)**

- WC-20-78A 10 mm
- WC-20-79A 15 mm
- WC-20-80A 20 mm



WC-20-80A

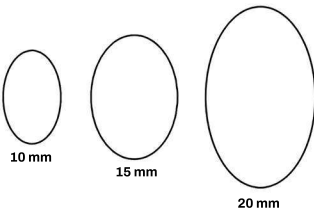

**Bruns Ring Curette**

- 9" (23 cm)  
WC121-45 5 mm inside ring diameter  
WC121-47 8 mm inside ring diameter  
WC121-46 10 mm inside ring diameter

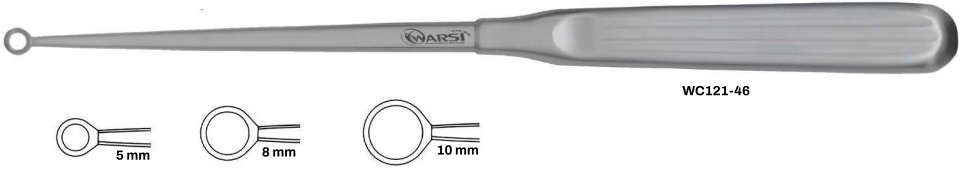

WC121-46

**Volkman Curette**

- Double-ended / oval cup - oval cup  
WC20-41 5 1/2" (14 cm)  
WC20-42 6 1/2" (16.5 cm)  
WC20-48 8" (20.5 cm)
- Double-ended / round cup - oval cup  
WC320-40 5" (13 cm)  
WC320-44 6 1/2" (16.5 cm)  
WC320-46 8" (20.5 cm)

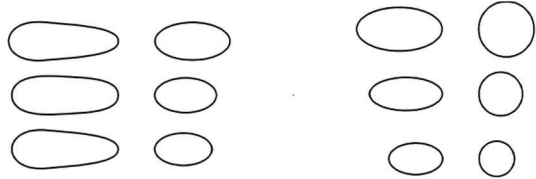

**Charnley Bone Curette**

- Sharp / double-ended / 6" (15 cm)  
WC20-761 straight round cups  
WC20-760 20° double-angled oval cups



• **Bruns Solid Hexagonal Curette**

• **Angled / solid hexagonal handle / oval / 9" (22.9 cm)**

- WC-32-80A size 000
- WC-32-81A size 00
- WC-32-82A size 0
- WC-32-83A size 1
- WC-32-84A size 2
- WC-32-85A size 3
- WC-32-86A size 4
- WC-32-87A size 5
- WC-32-88A size 6

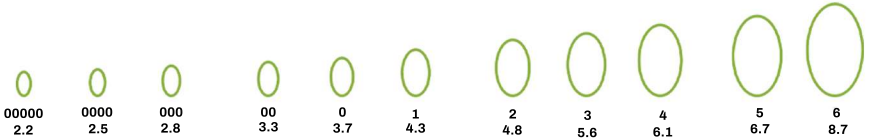

• **Bruns Hexagonal Handle Curette**

• **Solid hexagonal handle / 9" (23 cm)**

- WC-32-70 size 000
- WC-32-71 size 00
- WC-32-72 size 0
- WC-32-73 size 1
- WC-32-74 size 2
- WC-32-75 size 3
- WC-32-76 size 4
- WC-32-77 size 5
- WC-32-78 size 6

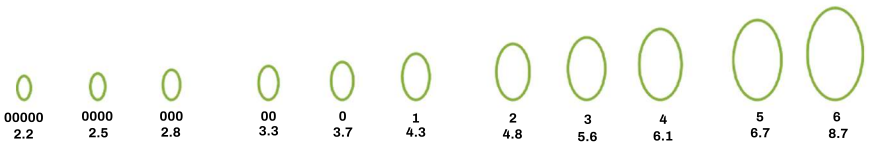

• **Bruns Oval Cup Curette**

• **Oval cup / straight / 6 3/4" (17 cm)**

- WC32-808 size 00000
- WC32-809 size 0000
- WC32-810 size 000
- WC32-811 size 00
- WC32-812 size 0
- WC32-813 size 1
- WC32-814 size 2
- WC32-815 size 3
- WC32-816 size 4
- WC32-817 size 5
- WC32-818 size 6

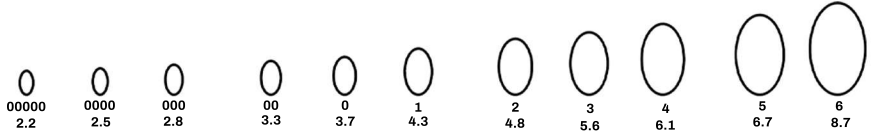

WC32-813

• **Oval cup / straight / 9" (23 cm)**

- WC320-827 size 00000
- WC320-829 size 0000
- WC320-830 size 000
- WC320-831 size 00
- WC320-832 size 0
- WC320-833 size 1
- WC320-834 size 2
- WC320-835 size 3
- WC320-836 size 4
- WC320-837 size 5
- WC320-838 size 6



WC320-834

• **Oval cup / straight / Angled / 9" (23 cm)**

- WC320-827 size 00000
- WC320-829 size 0000
- WC320-830 size 000
- WC320-831 size 00
- WC320-832 size 0
- WC320-833 size 1
- WC320-834A size 2
- WC320-835 size 3
- WC320-836 size 4
- WC320-837 size 5
- WC320-838 size 6



WC320-834A

• **Bruns Oval Cup Curette**

- **Oval cup / straight / phenolic handle /  
6 3/4" (17 cm)**  
WC-20-10P size 000  
WC-20-11P size 0



WC-20-10P



WC-20-11P

• **Charnley Ring Curette**

- 37cm/15" length
- Double sided
- Serrated cutting edge
- T-handle
- WC-32-8A



• **Toothed Bone Curette**

- 27cm/9¾" length
- Sharp spoon with teeth
- Tufnol handle
- WC-32-9A





# ORTHOPEDIC GOUGES



• **Smith-Petersen Gouge**

- **Straight / 8" (20.5 cm)**  
 WT-330-60 6 mm (1/4") tip, 330-631 9 mm (3/8") tip  
 WT-330-62 13 mm (1/2") tip, 330-633 16 mm (5/8") tip  
 WT-330-64 19 mm (3/4") tip, 330-635 25 mm (1") tip  
 WT-330-66 32mm (1 1/4") tip



WT-330-64



WT-330-66

- **Curved / 8" (20.5 cm)**  
 WT-330-40 6 mm (1/4") tip  
 WT-330-41 9 mm (3/8") tip  
 WT-330-42 13 mm (1/2") tip  
 WT-330-43 16 mm (5/8") tip  
 WT-330-44 19 mm (3/4") tip  
 WT-330-45 25 mm (1") tip  
 WT-330-46 32mm (1 1/2") tip



WT-330-46



WT-330-42



WT-330-41

**Cobb Type Spinal Gouge**

- 11" (20.5 cm)  
 WG-33-50 straight  
 WG-33-51 medium curve  
 WG-33-52 strong curve  
 WG-33-53 reverse curve

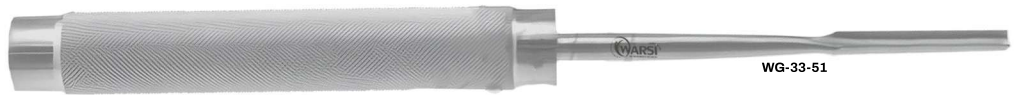
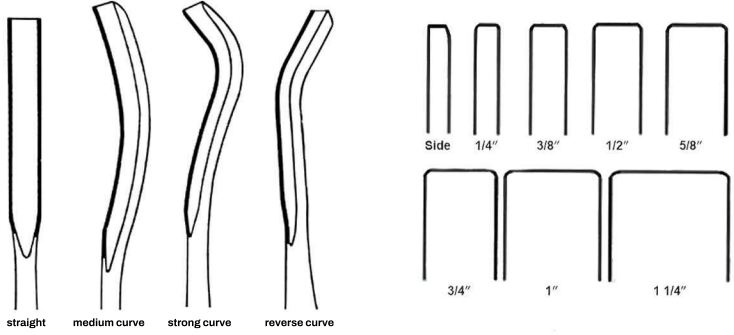

**Warsi Micro Gouge**

- 5 1/2" (14 cm)  
 WG-75-03 3mm  
 WG-75-04 4mm  
 WG-75-05 5mm  
 WG-75-06 6mm



• **Hibbs Gouge**

- **Straight / 9 1/2" (24.1 cm)**
  - WG-30-590 1/4"
  - WG-30-591 3/8"
  - WG-30-592 1/2"
  - WG-30-593 5/8"
  - WG-30-594 3/4"
  - WG-30-595 7/8"
  - WG-30-596 1"
  - WG-30-597 1 1/8"
  - WG-30-598 1 1/4"
  - WG-30-599 1 1/2"



WG-30-597

• **Curved / 9 1/2" (24.1 cm)**

- WG-30-600 1/4"
- WG-30-601 3/8"
- WG-30-602 1/2"
- WG-30-603 5/8"
- WG-30-604 3/4"
- WG-30-605 7/8"
- WG-30-606 1"
- WG-30-607 1 1/8"
- WG-30-608 1 1/4"
- WG-30-609 1 1/2"

• **Capener Lamina Gouge**

- **Width**
  - SP-66-23 6mm
  - SP-68-23 8mm
  - SP-61-23 11mm
  - SP-66-23 16mm
- Capener Lamina Gouge
- Crank Shaft



WG-30-597

• **Mini Lexer Gouge**

- 7" (18 cm)
  - WG-30-020 4 mm tip
  - WG-30-021 6 mm tip
  - WG-30-022 8 mm tip
  - WG-30-023 10 mm tip
  - WG-30-024 12 mm tip



• **Lexer Gouge**

- 8 3/4" (22.5 cm)
  - WG-30-030 7mm tip
  - WG-30-031 10 mm tip
  - WG-30-032 15 mm tip
  - WG-30-033 20 mm tip
  - WG-30-034 25 mm tip
  - WG-30-035 30 mm tip





# ORTHO OSTEOTOMES

● **Smith Peterson Osteotome**

● **Straight / 8" (20.5 cm)**

- WO33-610 1/4"
- WO33-611 3/8"
- WO33-612 1/2"
- WO33-613 5/8"
- WO33-614 3/4"
- WO33-615 1"
- WO33-616 1 1/4"



WO33-610



WO33-611



WO33-612



WO33-613



WO33-614



WO33-615

● **Curved / 8" (20.5 cm)**

- 330-620 1/4"
- 330-621 3/8"
- 330-622 1/2"
- 330-623 5/8"
- 330-624 3/4"
- 330-625 1"
- 330-626 1 1/4"

• **Hibbs Osteotome**

• **Straight / 9 1/2" (24 cm)**

- WO30-550 1/4"
- WO30-551 3/8"
- WO30-552 1/2"
- WO30-553 5/8"
- WO30-554 3/4"
- WO30-555 7/8"
- WO30-556 1"
- WO30-557 1 1/8"
- WO30-558 1 1/4"
- WO30-559 1 1/2"

• **Curved / 9 1/2" (24 cm)**

- WO30-570 1/4"
- WO30-571 3/8"
- WO30-572 1/2"
- WO30-573 5/8"
- WO30-574 3/4"
- WO30-575 7/8"
- WO30-576 1"
- WO30-577 1 1/8"
- WO30-578 1 1/4"
- WO30-579 1 1/2"



WO30-574

• **Lambotte Osteotome**

• **Straight / 9" (23 cm)**

- WO30-660 1/4" (6 mm)
- WO30-661 1/2" (13 mm)
- WO30-662 3/4" (19 mm)
- WO30-663 1" (25 mm)
- WO30-664 1 1/4" (32 mm)
- WO30-665 1 1/2" (38 mm)

• **Curved / 9" (23 cm)**

- WO30-670 1/4" (6 mm)
- WO30-671 1/2" (13 mm)
- WO30-672 3/4" (19 mm)
- WO30-673 1" (25 mm)
- WO30-674 1 1/4" (32 mm)
- WO30-675 1 1/2" (38 mm)



WO30-671

• **West Osteotome**

• **Square handle**

WO30-708 4 mm 6 1/2" (16.5 cm)

WO30-708A 6 mm 7 1/2" (19 cm)



WO30-708A

• **Hand Surgery Osteotome**

• **Straight / 5" (13 cm)**

- WO103-281 3/32" (2 mm)
- WO103-280 1/8" (3 mm)
- WO103-282 5/32" (4 mm)
- WO103-283 1/4" (6 mm)
- WO103-284 5/16" (8 mm)
- WO103-285 13/32" (10 mm)
- WO103-286 15/32" (12 mm)
- WO103-287 9/16" (14 mm)
- WO103-288 19/32" (15 mm)
- WO103-289 3/4" (19 mm)
- WO103-291 5/8" (16 mm)
- WO103-292 11/16" (18 mm)
- WO103-293 13/16" (20 mm)

• **Curved / 5" (13 cm)**

- WO103-281C 3/32" (2 mm)
- WO103-280C 1/8" (3 mm)
- WO103-282C 5/32" (4 mm)
- WO103-283C 1/4" (6 mm)
- WO103-284C 5/16" (8 mm)
- WO103-285C 13/32" (10 mm)
- WO103-286C 15/32" (12 mm)
- WO103-287C 9/16" (14 mm)
- WO103-288C 19/32" (15 mm)
- WO103-289C 3/4" (19 mm)
- WO103-291C 5/8" (16 mm)
- WO103-292C 11/16" (18 mm)
- WO103-293C 13/16" (20 mm)

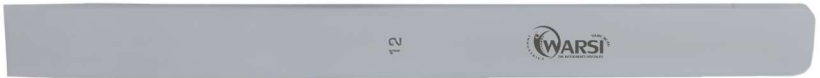

WO103-286

• **Sheehan Osteotome**

• **6 1/4" (16 cm)**

- WO30-882 2 mm
- WO30-883 3 mm
- WO30-884 4 mm
- WO30-885 5 mm
- WO30-886 6 mm
- WO30-887 7 mm
- WO30-888 8 mm
- WO30-889 9 mm
- WO30-890 10 mm
- WO30-891 11 mm
- WO30-892 12 mm
- WO30-895 15 mm



WO30-891

• **Hoke Osteotome**

• **Hex handle / straight / 5" (12.5 cm)**

- WO30-690 1/8" (3 mm)
- WO30-691 3/16" (4 mm)
- WO30-692 1/4" (6 mm)
- WO30-693 5/16" (8 mm)
- WO30-694 3/8" (10 mm)
- WO30-695 1/2" (13 mm)
- WO30-696 5/8" (16 mm)

• **Curved / 5" (12.5 cm)**

- WO30-700 1/8" (3 mm)
- WO30-701 3/16" (4 mm)
- WO30-702 1/4" (6 mm)
- WO30-703 5/16" (8 mm)
- WO30-704 3/8" (10 mm)
- WO30-705 1/2" (13 mm)
- WO30-706 5/8" (16 mm)



WO30-695

• **Cottle Plastic Osteotome**

• **Specially designed edge / heavy type / with end stop platform / with no corners on blade / 7" (18 cm)**

- WO30-849A 3/32" (2 mm)
- WO30-849B 5/32" (4 mm)
- WO30-849C 9/32" (7 mm)
- WO30-849D 11/32" (9 mm)
- WO30-849E 15/32" (12 mm)



WO30-849C

• **Stille Osteotome**

• **Hexagonal handle / 8" (20.5 cm)**

- WO30-730 13/32" (10 mm)
- WO30-731 9/16" (14 mm)
- WO30-732 23/32" (18 mm)
- WO30-733 7/8" (22 mm)



WO30-732

• **Hardt Micro Cartilage Osteotome Set (with bag)**

• **5 1/8" (13.25 cm)**

**330-799-SET includes:**

- WO30-801M 3/32" (2 mm)
- WO30-802M 5/32" (4 mm)
- WO30-803M 1/4" (6 mm)
- WO30-804M 5/16" (8 mm)
- WO30-805M 13/32" (10 mm)
- WO30-806M 15/32" (12 mm)
- WO30-807M 19/32" (15 mm)

**6 3/4" (17 cm)**

**330-800M-SET includes:**

- WO30-790M 3/32" (2 mm)
- WO30-791M 5/32" (4 mm)
- WO30-792M 1/4" (6 mm)
- WO30-793M 5/16" (8 mm)
- WO30-794M 13/32" (10 mm)
- WO30-795M 15/32" (12 mm)
- WO30-796M 19/32" (15 mm)

**WO30-799B Canvas Osteotome Bag**

Hardt Osteotomes also available individually



WO30-799B



WO30-800M



Side View



WO30-796M



WO30-795M



WO30-794M



WO30-793M



WO30-792M



WO30-791M



WO30-790M

- **Warsi-Cottle Osteotome Set**
- **Graduated markings / 7" (18 cm)**

WO100-479-SET set includes:

7 osteotomes and canvas bag

2 mm, 3 mm, 4 mm, 6 mm, 8 mm, 10 mm, 12 mm

WO100-479K 2 mm

WO100-479M 3mm

WO100-479L 4 mm

WO100-479A 6 mm

WO100-479B 8 mm

WO100-479C 10 mm

WO100-479D 12 mm

WO100-479E 14 mm

WO100-479F 16 mm

WO100-479G 18 mm

WO100-479N 19mm

WO100-479J 20 mm

WO100-479H 22 mm

WO30-799B canvas bag

WO30-799B

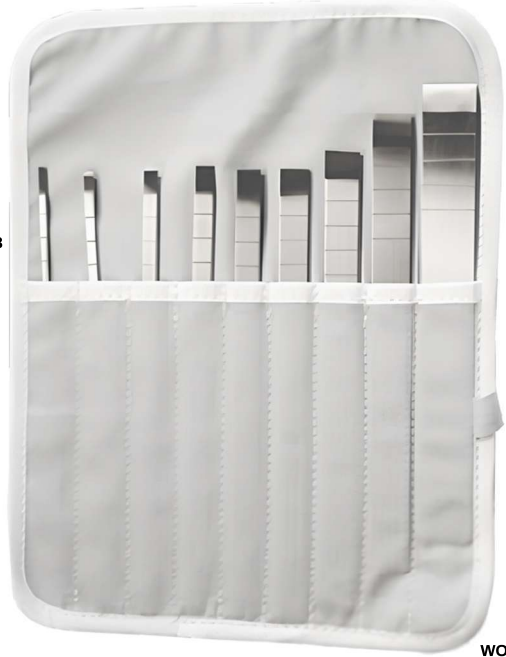

WO100-479



WO100-479A



WO100-479B



WO100-479C



WO100-479D



WO100-479G



WO100-479H

• **Mini Lexer Osteotome**

• **Small handle / 7" (18 cm)**

- WO30-001 4 mm tip
- WO30-002 6 mm tip
- WO30-003 8 mm tip
- WO30-004 10 mm tip
- WO30-005 12 mm tip



WO30-003

- 4 mm
- 6 mm
- 8 mm
- 10 mm
- 12 mm

• **Lexer Osteotome**

• **Large handle / 8 3/4" (22.5 cm)**

- WO30-010 7 mm tip
- WO30-011 10 mm tip
- WO30-012 15 mm tip
- WO30-013 20 mm tip
- WO30-014 25 mm tip
- WO30-015 30 mm tip



WO30-012

- 7 mm
- 10 mm
- 15 mm
- 20 mm
- 25 mm
- 30 mm

• **Lexer Osteotome**

• **Large handle / 12" (30.5 cm)**

- WO30-016 10 mm tip
- WO30-017 12 mm tip
- WO30-018 15 mm tip



WO30-017

- 10 mm
- 12 mm
- 15 mm

• **Obwegeser Split Osteotome**

• 8 3/4" (22.5 cm)

WO30-120 8 mm tip

WO30-125 12 mm tip

WO30-130 16 mm tip

WO30-135 20 mm tip



• **Obwegeser Wedge Osteotome**

• 8 3/4" (22.5 cm)

WO30-100 8 mm tip

WO30-105 12 mm tip

WO30-110 16 mm tip



• **Ultra Fine Osteotome (Titanium Nitrate Coated)**

• **16cm/6¼" length**

- HA230-02 2mm
- HA230-04 4mm
- HA230-06 6mm
- HA230-08 8mm
- HA230-10 10mm
- HA230-12 12mm



HA230-06



**Set of 6 sizes: 2mm to 12mm**  
complete with mallet in  
sterilising case  
HA230-48

• **Mini- Stille Osteotome**

• **16cm/6¼" length**

- Straight Width
- SP704-16 4mm
  - SP706-16 6mm
  - SP708-16 8mm



SP706-16

• **Stille (Swedish) Osteotome**

• **20cm/8" length**

- Straight Width
- SP706-20 6mm
  - SP708-20 8mm
  - SP710-20 10mm
  - SP712-20 12mm
  - SP715-20 15mm
  - SP720-20 20mm
  - SP725-20 25mm
  - SP730-20 30mm



SP712-20

**Dahmen Osteotome**

• 30cm/12" length

Tufnol handle / Straight / Angled

SP31-610

SP31-610

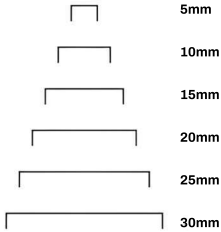

Straight	Width
SP105-30	5mm
SP110-30	10mm
SP115-30	15mm
SP120-30	20mm
SP125-30	25mm
SP130-30	30mm



Angled	Width
SP305-30	5mm
SP310-30	10mm
SP315-30	15mm
SP320-30	20mm
SP325-30	25mm
SP330-30	30mm

**Smith Petersen Osteotome**

• 20cm/8" length

- SP610-20 10mm
- SP715-20 15mm
- SP620-20 20mm
- SP625-20 25mm
- SP630-20 30mm

SP715-20



**Hibbs Osteotome with thin blade**

• 20cm/8" length

Extra thin blade / Curved / Straight

SP716-20



SP716-20

**Pelvic Osteotome**

• 30cm/12" length

Tufnol handle / Angled shaft

- SP015-30 15mm width
- SP020-30 20mm width



SP020-30



# ORTHOMALLET HAMMER

• **London Splint Mallet**

- 18cm/7" length
- Head size 30mm Ø
- Weight 450g/16.2oz
- WM-30-844



• **Mallet with Tufnol Handle**

- 23cm/9" length
- Small head size 30mm Ø
- Weight 350g/12oz
- Medium head size 35mm Ø
- Weight 550g/20oz
- Large head size 40mm Ø
- Weight 700g/25oz



• **Ombredanne Mallet**

- 19cm/7" length
- Stainless steel head
- Head size 40mm Ø
- Weight 1020g/36oz



• **Mallet with Tufnol Handle**

- **24cm/9½" length**  
**Lead filled head**  
**Weight 400g/14oz**  
**WM-83-888**



WM-83-888

• **Tufnol Mallet**

- **25.5cm/10" length**  
**Head size 42mm Ø**  
**Weight 250g/10oz**  
**WM-83-889**



WM-83-888

• **Warsi Combo Nylon Mallet**

- 1" head diameter / removable heads / 7 3/8" (18.75 cm)  
WM-100-462S deluxe mallet with one nylon head  
Sold separately  
WM-100-462SH stainless steel head for deluxe mallet  
WM-100-463S nylon head for deluxe mallet



• **Warsi Double Nylon Mallet**

- Light-weight / 7 3/8" (18.7 cm) / 7 oz.  
WM-30-808



• **No Recoil Mallet**

• **One sided nylon head / no recoil**

WM-330-23 9 3/4" (25 cm) 500 g 35mm diameter head

WM-330-27 9" (23cm) 300 g 27mm diameter head



• **Phenolic Spinal Mallet**

• **10 1/4" (26.5 cm)**

WM-330-44 35 mm 150 g

WM-330-45 45 mm 240 g

WM-330-46 50 mm 330 g

**9 1/2" (24 cm) / Steinbach style**

WM-330-47 60 mm 400 g



WM-330-46



WM-330-47

• **Toffee Mallet**

- | 19cm/7½" length
- | Head size 22mm Ø
- | Weight 165g/6oz
- MA-508-21



MA-508-21

• **Ultra Fine Mallet**

- | 17cm/6¾" length
- | Head size 20mm Ø
- | Weight 145g/5oz
- MA-508-22



MA-508-22

• **Heath Mallet**

- | 19cm/7" length
- | Stainless steel head
- | Head size 40mm Ø
- | Weight 1020g/36oz
- MA-508-23



MA-508-23

• **Sontec Large Mallet**

- 10 3/4" (26.5 cm)
- 330-635 1 pound (450 g)
- 330-634 2 pounds (900 g)



WM-330-635

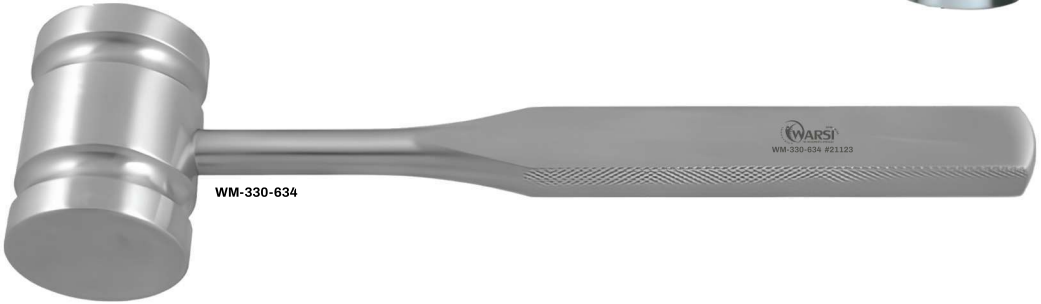

WM-330-634

• **USA Model Mallet**

- 1" diameter / 1 lb USA model / 7 1/4" (18.4 cm)
- WM-330-833

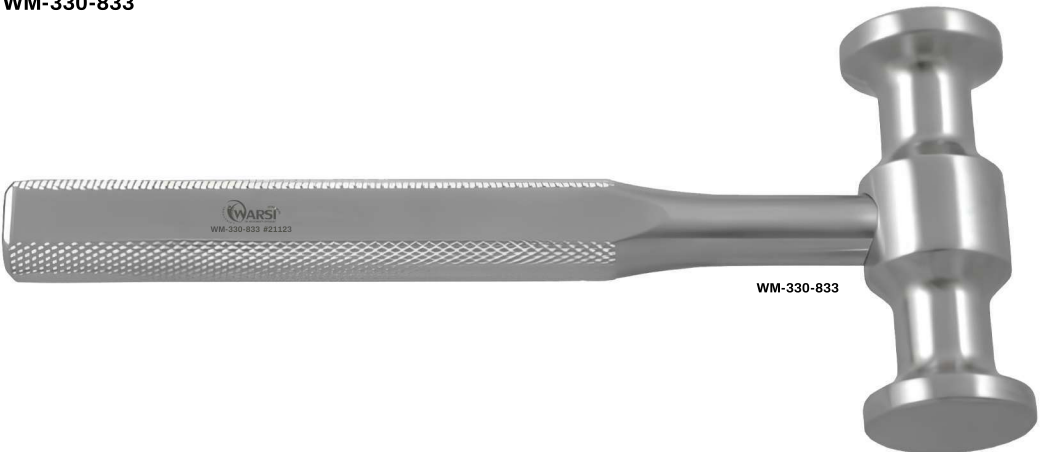

WM-330-833

• **Warsi Micro Mallet**

- 3/4" head diameter / 6 1/2" (16.5 cm)  
WM-330-917 stainless steel convex/flat combo 4 oz.  
WM-330-919 lead filled head no recoil 5.6 oz.



WM-330-917

• **Mead Mallet**

- 3/4" head diameter / 7 1/2" (19 cm) / 8 oz. head  
/ w/replacement nylon caps  
WH-330-914  
Replacement caps  
WM-330-914R



WM-330-914

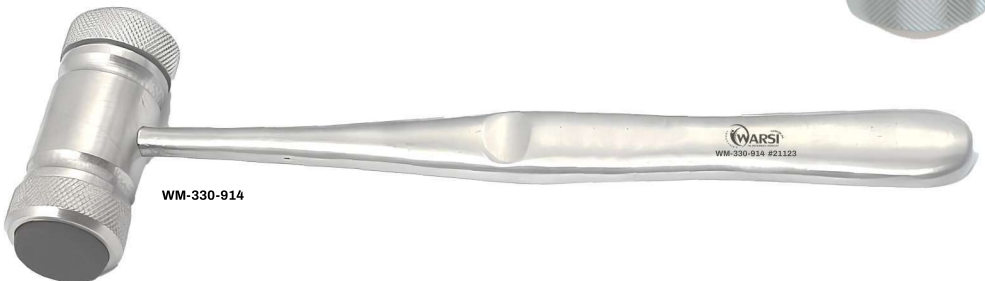

WM-330-914

• **Brass Head Mallet**

- 7 3/4" (20 cm)  
WM-30-81



WM-30-81

• **Large Sontec Combo Mallet**

- 1 1/2" head / replaceable heads / 8" (20.5 cm)  
WM-330-24  
WM-330-24S stainless & nylon head  
Replaceable heads / 1 1/2" (3.8 cm)  
WM-330-24NH nylon  
WM-330-24SH stainless steel



WM-330-24NH



WM-330-24SH



WM-330-24

• **Cottle Mallet**

- Convex flat combo / 7 1/2" (19.1 cm)  
WM-110-61S stainless steel head  
WM-110-61



• **Collin Lucae Mallet**

- Solid head / 210 grams /  
30mm Ø / 8 1/4" (21 cm)  
WM-30-18  
WM-30-18G

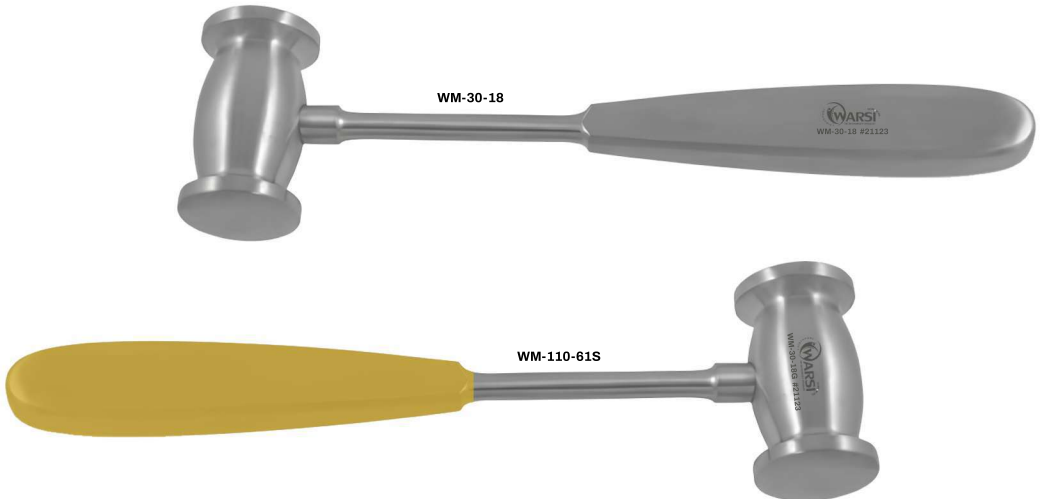

• **Heavyweight Mallet**

- 1 1/2" head diameter / 7 1/4" (18.5 cm)  
WM-30-832 1.72 lbs  
WM-30-832G 1.72 lbs



WM-30-832



WM-30-832



WM-30-832G

• **AO Type Mallet**

- Fenestrated handle / AO type / 9" (23 cm)  
WM-30-839



WM-30-839

• **Warsi Large Handle Mallet**

• **Ribbed phenolic handle**

330-840 10 1/4" (26 cm) 1 3/4" head dia. 3 lbs  
330-842 10 1/4" (26 cm) 1 1/4" head dia.



WM-30-840

• **Warsi Large Handle Mallet**

• **Ergonomic phenolic handle / 1 1/4" head diameter**

WM-30-841 8 3/4" (22 cm)



WM-30-841



# ORTHO MENISCOTOME & KNIFE



• **Smillie Meniscotome**

- **Straight blade / 6 3/4" (17 cm)**  
WK103-20



WK103-20

• **Nixon XXL Banana Knife**

- **Double sided / wide blade / serrated / 9" (23 cm)**  
WK271-39C curved  
WK271-39D straight



WK271-39D

• **Winberg Bistouri Knife**

- **7" (18 cm)**  
WK271-57



• **Foerner Sesmoid Knife Elevator**

- **Curved / 5 mm tip / 6 1/4" (16 cm)**  
WK404-75



• **Femoral Head Disarticulator Knife**

• **Curved**

WK103-211 Small 5 1/2" (14 cm)

WK103-213 Large 7 1/2" (19 cm)



WK103-213



WK103-211

• **V Blade Meniscotome**

• **Flat handle / 6 3/4" (17 cm)**

WK103-206

• **Curved / 8" (20.5 cm)**

WK103-209



WK103-209

• **Mini V-Blade Meniscotome**

• **Flat handle / 6 3/4" (17 cm)**

WK103-203 3mm



WK103-203

• **Rosin Root Meniscotome**

- **Curved "V" blade / 6 1/4" (16 cm)**  
WK-50-36



WK-50-36

• **Piermattei Smillie Meniscotome**

- **6 3/4" (17 cm)**  
WK-03-05



WK-03-05

• **Braake Tendon Knife**

- **Angled down / carbon coated shaft / 7" (18 cm)**  
WK-271-83



WK-271-83



# ORTHOPEDIC PLATE BENDERS

• **Rosin Root Meniscotome**

- **Curved "V" blade / 6 1/4" (16 cm)**  
PB-50-36



PB-50-36

• **Piermattei Smillie Meniscotome**

- **6 3/4" (17 cm)**  
PB-103-05



PB-103-05



• **Braake Tendon Knife**

- **Angled down / carbon coated shaft / 7" (18 cm)**  
PB-271-83



PB-271-83

• **Rosin Root Meniscotome**

- **Curved "V" blade / 6 1/4" (16 cm)**  
PB-50-836



PB-50-836

• **Piermattei Smillie Meniscotome**

- **6 3/4" (17 cm)**  
PB-103-205



• **Braake Tendon Knife**

- **Angled down / carbon coated shaft / 7" (18 cm)**  
BP-21-183



• **Plate Bending Table Top Press**

- Bends plates up to 6 mm / rotatable anvil / 17" (43 cm) in length  
PB-106-185



PB-106-185



PB-106-185

WARSI  
PB-106-185 #21123

• **Lateral Plate Bending Pliers**

- Bends 2.7 mm x 3.5 mm / contours plates /  
10 1/4 (26 cm)  
PB-55-24



PB-55-24 #21123

PB-55-24

• **Whale Nose Plate Bending Pliers**

- Bends small plates up to 2.7 mm / 7 3/4" (19.5 cm)

PB-55-230

- Bends large plates up to 3.5 mm / 9 1/2" (24 cm)

PB-55-235



• **AO Type Bending Pliers Set**

- For straight plates / with 2 anvils / 10" (25.4 cm)

/ comes with 355-236N & 355-236B

PB-55-236-SET

**Plates for Bending Pliers**

PB-55-236A for small plates

PB-55-236B for broad plates

PB-55-236N for narrow plates





# ORTHOPEDIC RETRACTORS

• **Gelpi Deep Angle Retractor**

- WR-100-629A 3 1/2"(9 cm)
- WR-100-628A 4 1/2"(11.5 cm)
- WR-100-628C 5 1/2"(14 cm)
- WR-100-631 6 3/4"(17.5 cm)
- WR-100-631S 6 3/4"(17.5 cm)
- WR-100-631T 4.5 mm prong 3 cm deep
- WR-100-631A 7 1/2"(19 cm)
- WR-100-631B 8" (20 cm)

\* Custom blunt or shortened tips available upon request



WR-100-628C



WR-100-628C

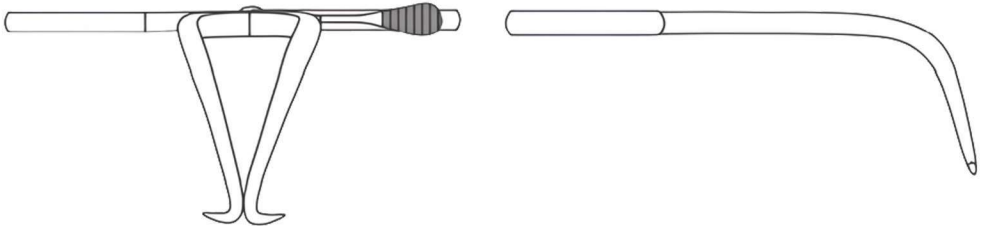

• **Gelpi Retractor**

- Deep half angle / 7 1/2" (19 cm)  
WR-100-615 sharp  
WR-100-617 blunt

\* Custom blunt or shortened  
tips available upon request

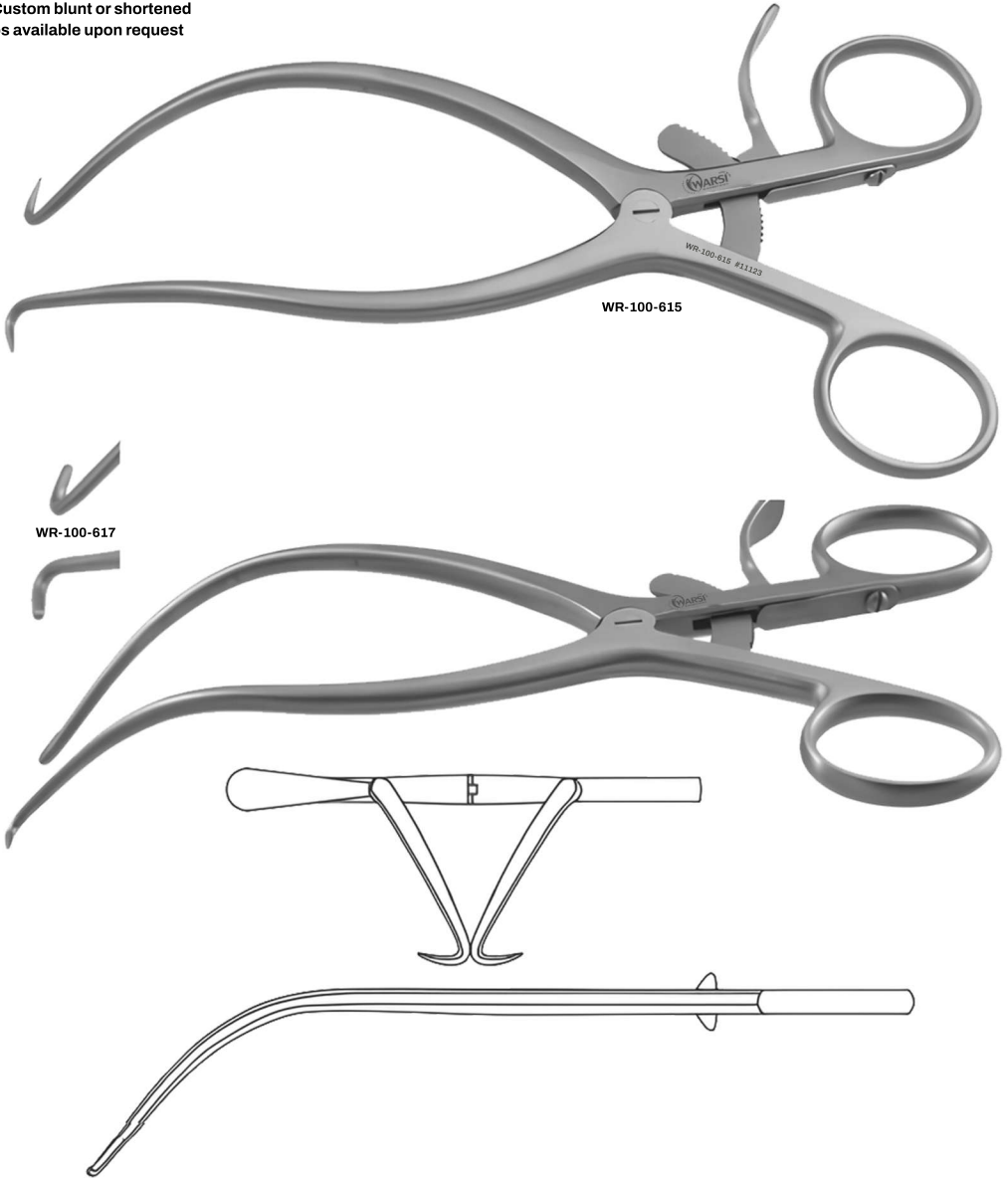

● **Gelpi Neroma (Crossover) Retractor**

- WR-1100-63A 4 1/2" (11.5 cm)
- WR-1100-63 m
- WR-1100-63 5 1/2" (14 cm)
- WR-1100-63C 6 1/2" (16.5 cm)
- WR-1100-63D 7 1/2" (19 cm)
- WR-1100-63E 3 1/2" (9 cm) heavy

**Enclosed ratchet version**

- WR-1100-63BR 3 1/2" (9 cm)

\* Custom blunt or shortened tips available upon request

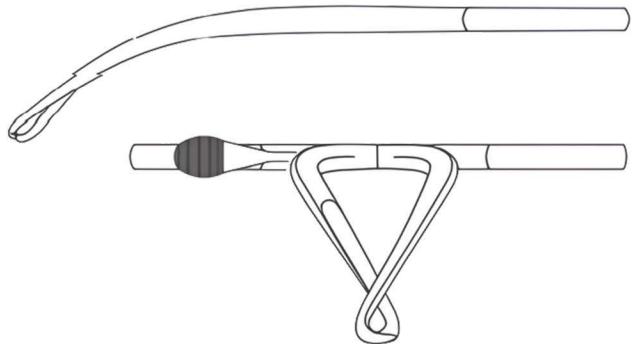

• **Gelpi Deep Angle Neroma (Crossover) Retractor**

• **Deep angle**

- WR-110-633H 3 1/2" (9 cm)
- WR-110-633G 4 1/2" (11.5 cm)
- WR-110-633F 5 1/2" (14 cm)
- WR-110-633I 6 1/2" (16.5 cm)
- WR-110-632R 6 3/4" (17.5 cm)
- WR-110-630N 7 1/2" (19 cm)
- WR-110-631N 8" (20 cm)

**Enclosed ratchet / deep angle**

- WR-110-633HR 3 1/2" (9 cm)
- WR-110-633GR 4 1/2" (11.5 cm)
- WR-110-633FR 5 1/2" (14 cm)

\* Custom blunt or shortened tips available upon request



WR-110-633F



Enclosed Ratchet



WR-110-633F

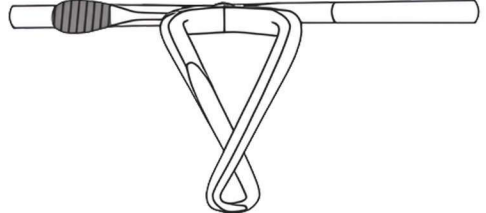
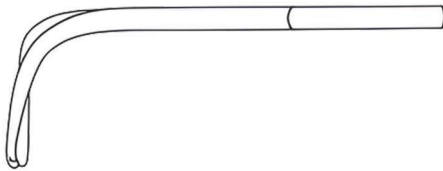

• **Gelpi Classic Retractor**

• **2 cm across / angle medium blunt tips / 6" (15.2 cm)**

WR-100-632AC

\* Custom blunt or shortened tips available upon request

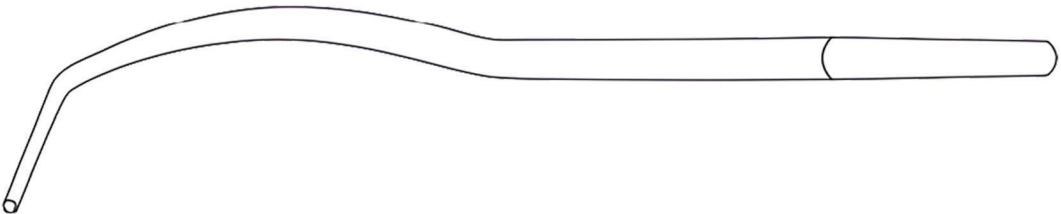
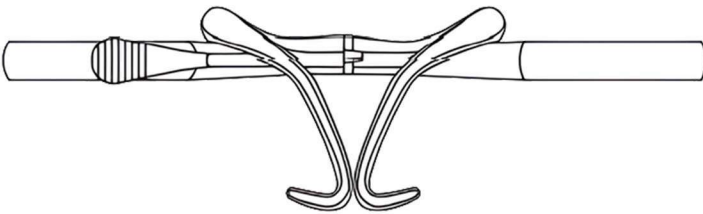
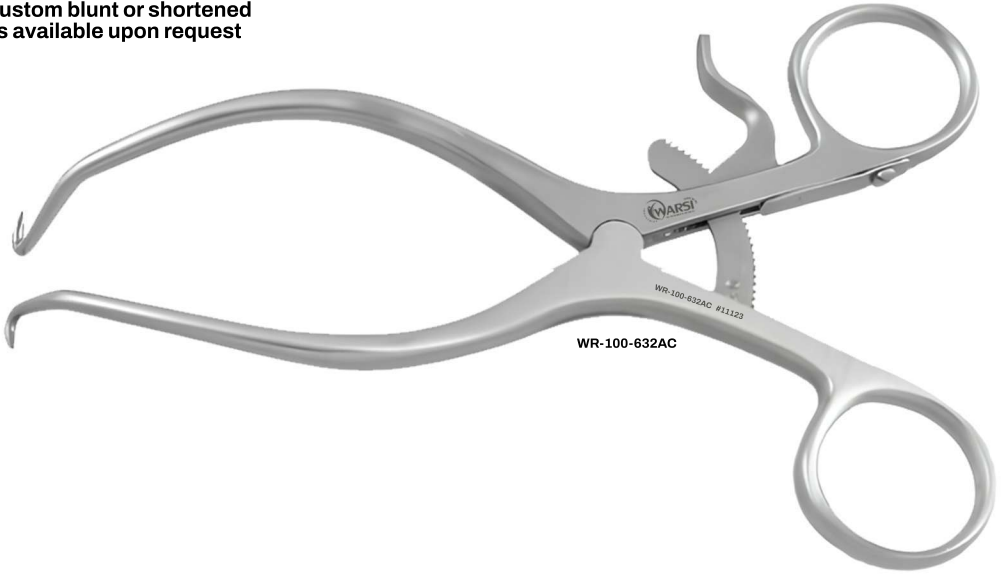

• **Gelpi Classic Retractor**

• **Standard**

- WR-100-629 3 1/2" (9 cm) micro
- WR-100-628 3 3/4" (9.5 cm) heavy
- WR-100-629B 4 1/2" (11.5 cm)
- WR-100-6280 4 1/2" (11.5 cm) heavy
- WR-100-628B 5 1/2" (14 cm)
- WR-100-632 6 1/2" (16.5 cm)
- WR-100-630 7 1/2" (19 cm)
- WR-100-630A 8" (20 cm)

\* Custom blunt or shortened tips available upon request



WR-100-629B

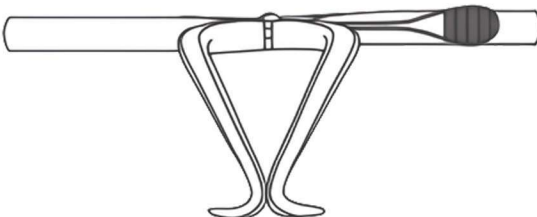
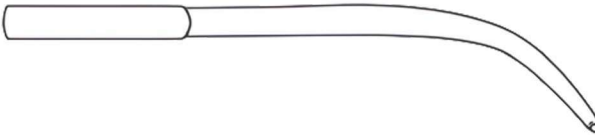

- **Gelpi Retractor**
- **Enclosed ratchet / 7 1/2" (19.1 cm)**  
WR-1100-30ER

\* Custom blunt or shortened tips available upon request

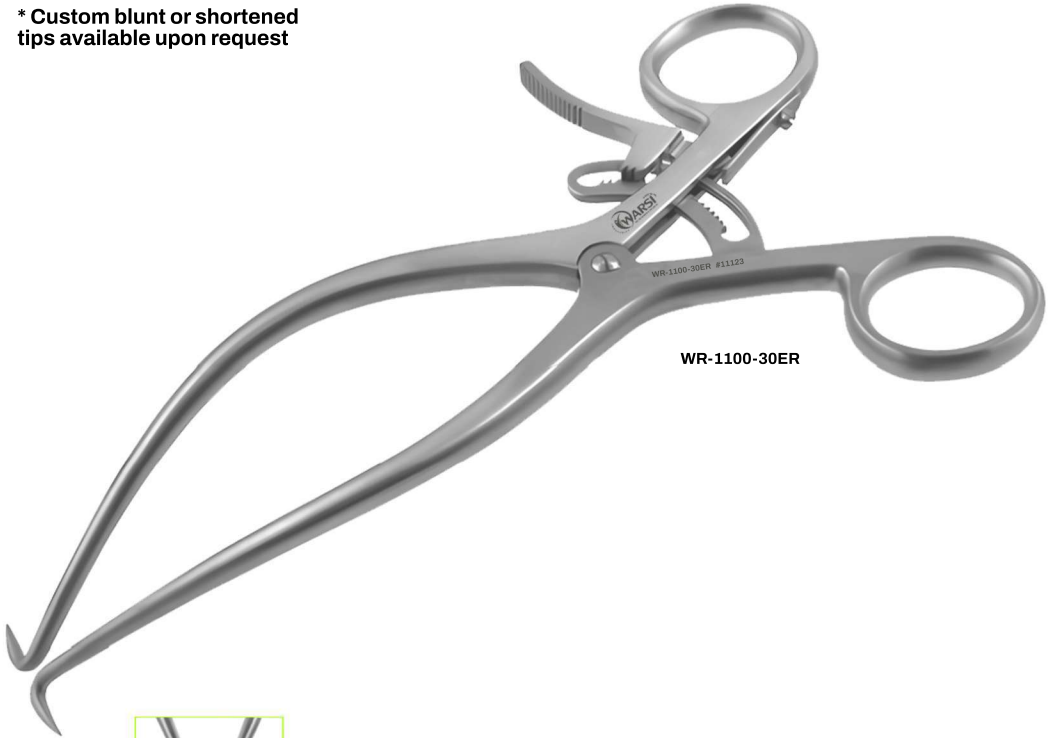

WR-1100-30ER



• **Gelpi Retractor**

• **Angle medium blunt tips / with enclosed ratchet**

- WR-100-62AR-7 2 cm deep angle 7"
- WR-100-62AR-8 3 cm deep angle 8"

\* Custom blunt or shortened tips available upon request

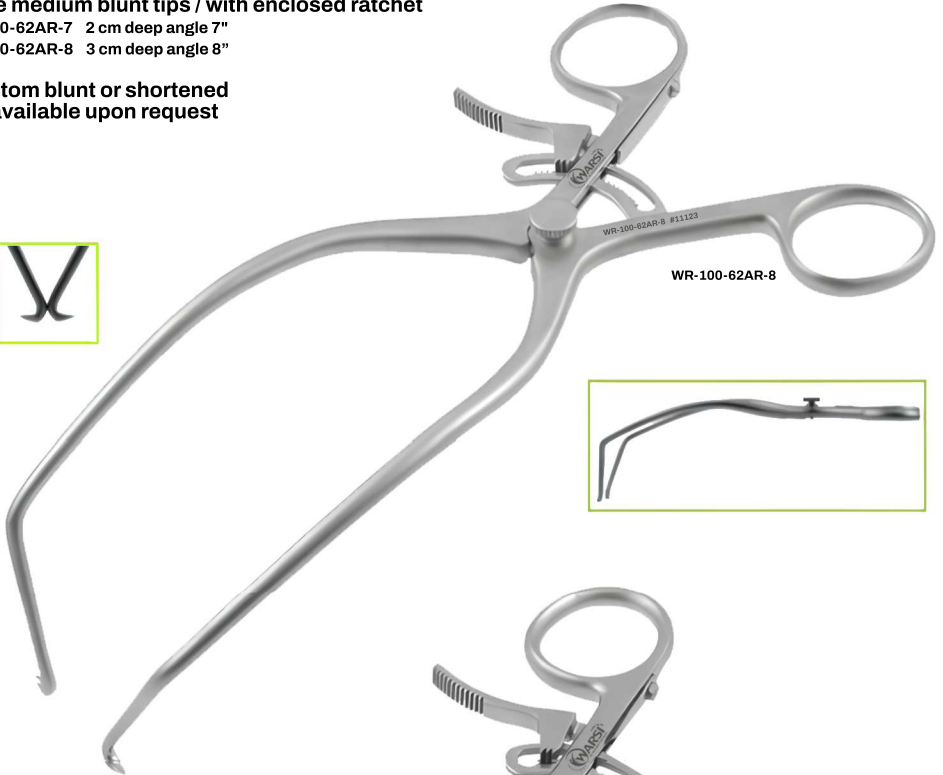

WR-100-62AR-8

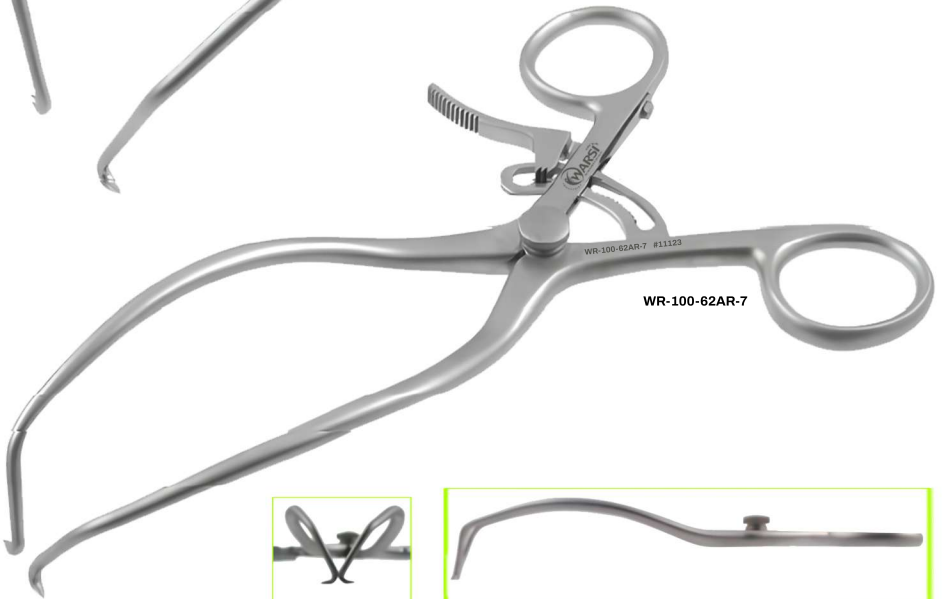

WR-100-62AR-7



• **Gelpi 1st Generation Deep Angle Retractor**

• **Original deep angle**

- WR-1100-29G 3 1/2" (9 cm)
- WR-1100-28G 4 1/2" (11.5 cm)
- WR-1100-32G 5 1/2" (14 cm)
- WR-1100-31G 6 1/2" (16.5 cm)
- WR-1100-30G 7 1/2" (19 cm)

**Original deep angle with enclosed ratchet**

- WR-1100-29GR 3 1/2" (9 cm)
- WR-1100-28GR 4 1/2" (11.5 cm)
- WR-1100-32GR 5 1/2" (14 cm)
- WR-1100-31GR 6 1/2" (16.5 cm)
- WR-1100-30GR 7 1/2" (19 cm)

\* Custom blunt or shortened tips available upon request



1st generation deep angle

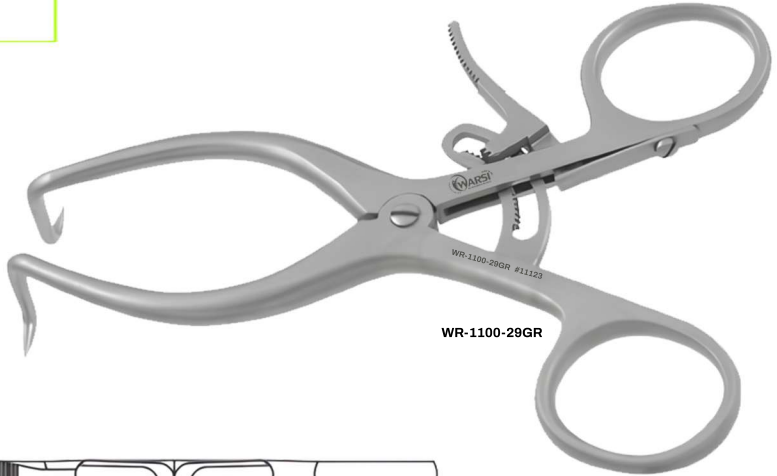

• **Gelpi Offset Arm Left & Right**

• **3 1/2"**

WR-110-332 left 5/8" (17mm) x 1" (25mm)  
WR-110-333 right 1" (25mm) x 5/8" (17mm)

**4 1/2"**

WR-110-282 left 7/8" (22mm) x 1 1/4" (32mm)  
WR-110-283 right 1 1/4" (32mm) x 7/8" (22mm)

**5 1/2"**

WR-110-292 left 1" (25mm) x 1 1/2" (38mm)  
WR-110-293 right 1 1/2" (38mm) x 1" (25mm)

**6 1/2"**

WR-110-312 left 1 5/8" (42mm) x 2 1/8" (53mm)  
WR-110-313 right 2 1/8" (53mm) x 1 5/8" (42mm)

**7 1/2"**

WR-110-322 left 1 1/4" (32mm) x 2 1/4" (57mm)  
WR-110-323 right 2 1/4" (57mm) x 1 1/4" (32mm)

**8"**

WR-110-334 left 2" (51mm) x 2 1/2" (67mm)  
WR-110-335 right 2 1/2" (67mm) x 2" (51mm)

\* Custom blunt or shortened tips available upon request

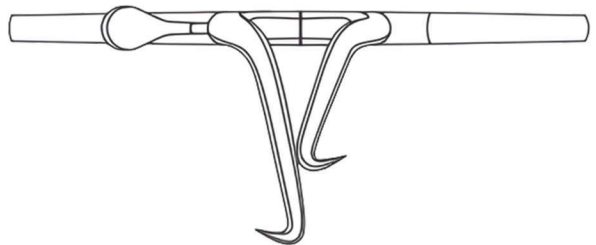
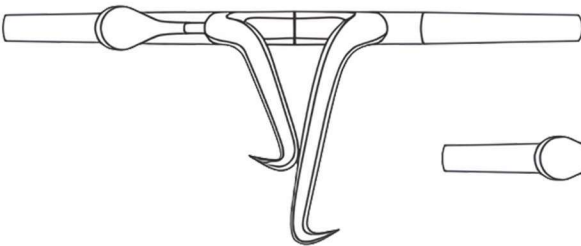

• **Foremann Kwire Distractor**

- **WS-47-02** small closed arms 6"
- **WS-47-02A** small outspread arms 6"
- **WS-47-02B** large closed arms 8 1/4"
- **WS-47-02C** large outspread arms 8 1/4"

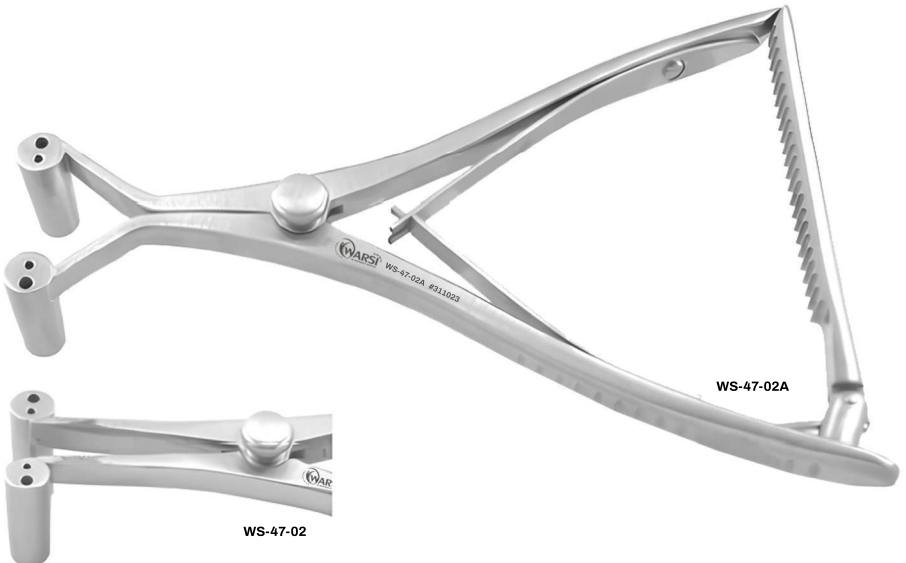

- **Foremann Kwire Distractor**

- Tapered arms / 7 1/2" (19.1 cm)  
WR-47-062

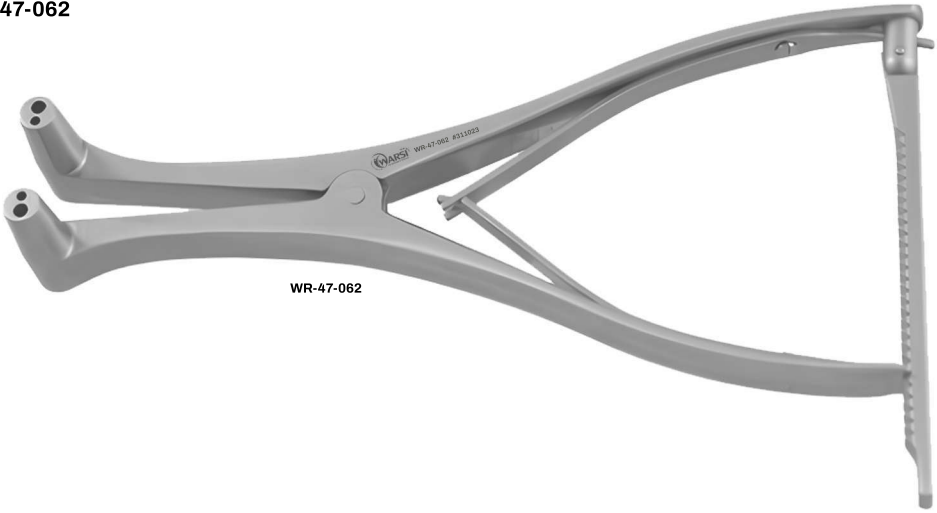

WR-47-062

- **Mini Foremann Distractor**

- Tapered arms / 5" (12.7 cm)  
WR-47-061

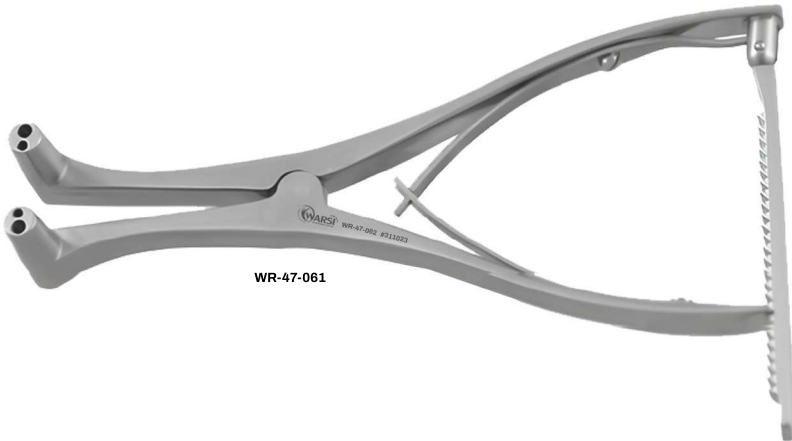

WR-47-061

• **Davis Stifle Retractor**

- With speed lock / 6 3/4" (17 cm)  
WR-13-290

\* Custom blunt or shortened tips available upon request



• **Allen Inge Stifle Retractor**

- With speed lock / 11" (27.9 cm)  
WR-13-297

\* Custom blunt or shortened tips available upon request

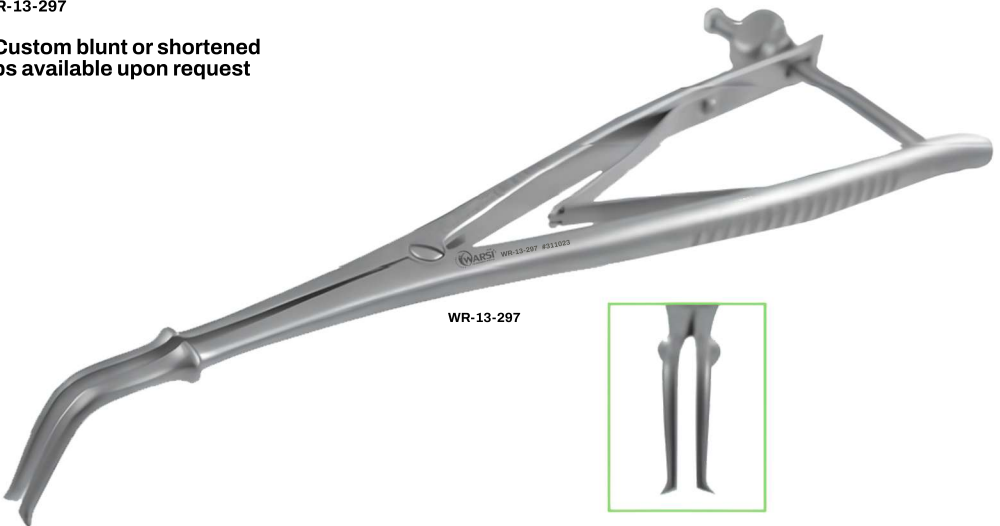

- **Inge Neroma Retractor**

- **With crossover tip / 6 1/2" (16.5 cm)**

WR-47-048 with speedlock  
WR-47-048R with ratchet

\* Custom blunt or shortened  
tips available upon request



- **Mini Inge Neroma Retractor**
- **Mini Inge Neroma Retractor**  
**With crossover tip / speed lock / 5" (12.7 cm)**  
WR-47-0482

\* Custom blunt or shortened tips available upon request



- **Mini Inge Neroma Ceramitec Retractor**
- **With crossover tip / speed lock / 5" (12.7 cm)**  
WR-47-0482B

\* Custom blunt or shortened tips available upon request



• **Wellace Stifle Retractor**

- Improved retraction / turn-key action
- WR-10-635 standard
- WR-10-635C crossover style



• **Sisson Spring Retractor**

- Sharp / 1 x 1 prongs / with ratchet / 4" (10 cm)
- WR-20-114

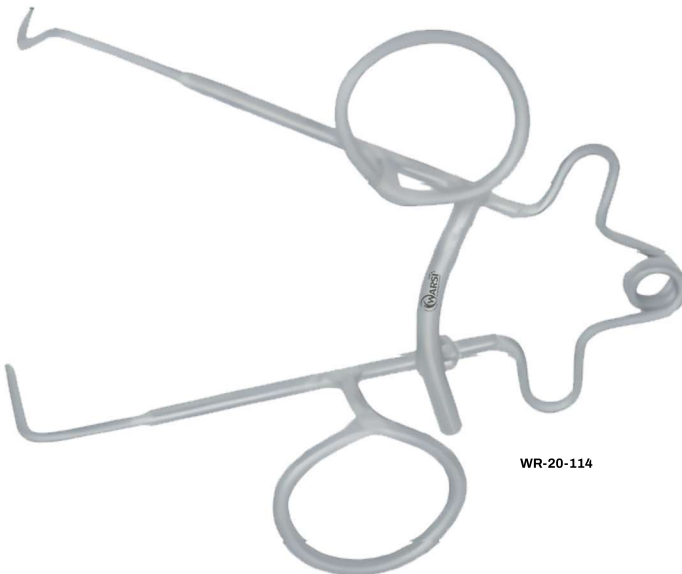

• **Vickers Self-Retaining Retractor**

- **WR-220-20 solid blades 3 1/8 (8 cm)**
- **WR-220-22 2 blunt blades 2 7/8 (7 cm)**
- **WR-220-24 3 blunt blades 3 1/2 (9 cm)**

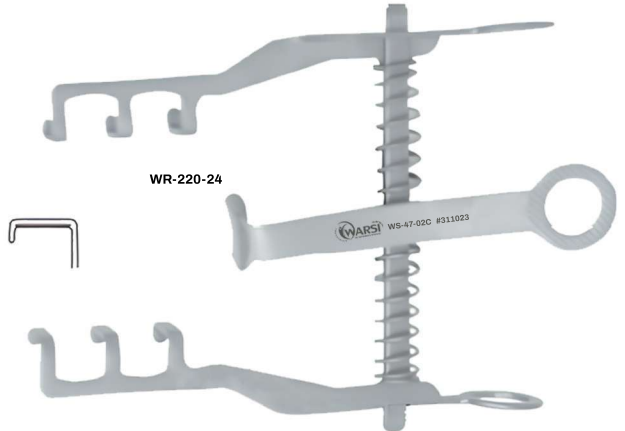
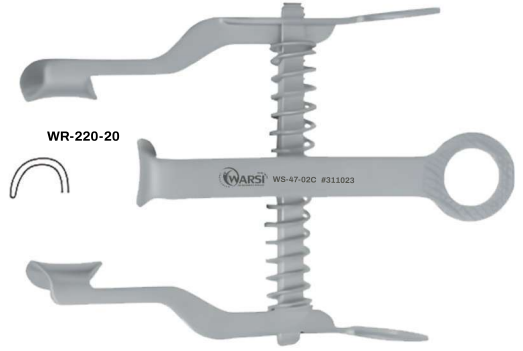

• **Finsen Self-Retaining Retractor**

• **2 x 3 prongs**

- WR-20-128 sharp 2" (5 cm)
- WR-20-126 blunt 2" (5 cm)
- WR-20-136 blunt 3 1/8" (7.5 cm)

• **3 x 4 prongs**

- WR-20-132 sharp 2 3/4" (7 cm)
- WR-20-130 blunt 2 3/4" (7 cm)
- WR-20-140 sharp 2 3/4" (7 cm) with adjustment screw
- WR-20-138 blunt 2 3/4" (7 cm) with adjustment screw

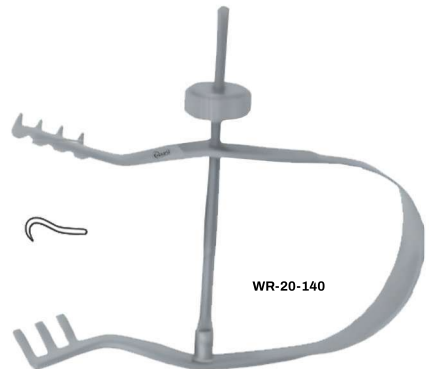
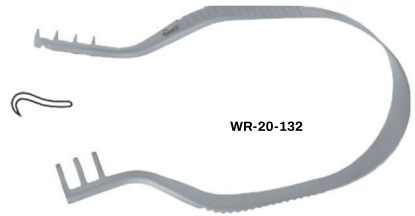
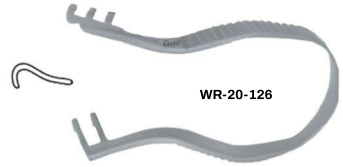

● **Charnley Initial Incision Retractor**

● **Round frame set**

9-15-450-02-SET

**Complete set includes the following:**

9-15-452-20 round frame

9-15-452-02 small blade 25mm x 65mm

9-15-452-08 large blade 25mm x 50mm

9-15-452-12 weight with chain

**Square frame set**

9-15-460-02-SET

**Complete set includes the following:**

9-15-462-20 square frame

9-15-462-02 small blade 25mm x 38mm

9-15-462-08 large blade 25mm x 44mm

9-15-462-12 weight with chain

**Additional blades are also available**

**Small blades**

9-15-462-18 25mm x 25mm

9-15-462-21 25mm x 50mm

9-15-462-23 25mm x 57mm

9-15-462-22 25mm x 63mm

9-15-462-07 25mm x 75mm

9-15-462-14 25mm x 101mm

9-15-462-16 25mm x 127mm

9-15-462-27 25mm x 114mm

**Large blades**

9-15-462-19 25mm x 25mm

9-15-462-26 25mm x 50mm

9-15-462-24 25mm x 57mm

9-15-462-09 25mm x 63mm

9-15-462-13 25mm x 75mm

9-15-462-15 25mm x 101mm

9-15-462-17 25mm x 127mm

9-15-462-28 25mm x 114mm

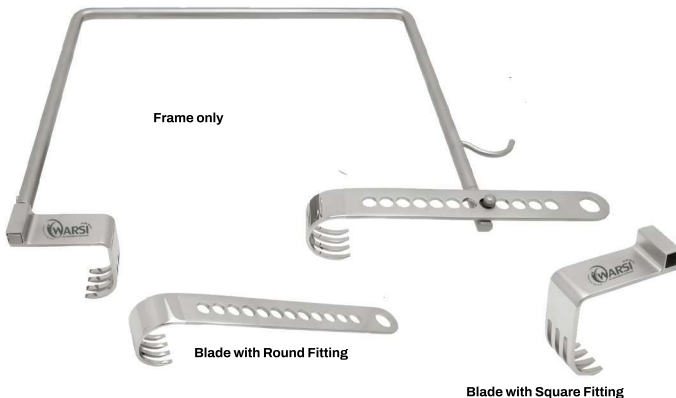
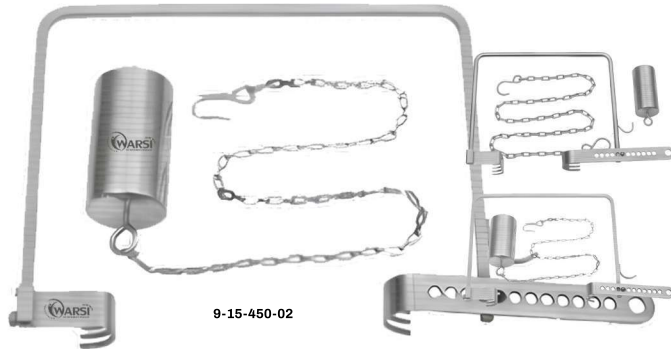
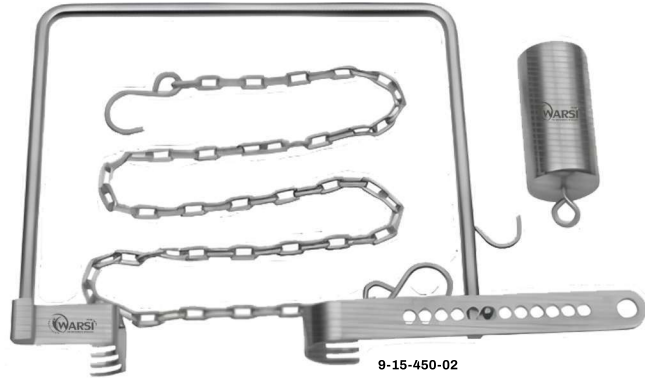

To spread the incision in the fascia lata. It is combined with a weight and chain, which tilts the retractor to an angle of 45° to improve exposure of the anterior aspect of the joint.

• **Slocum Type Army Navy Retractor**

- **Double ended**  
6 1/2" (16.5 cm)  
WR-27-25



• **Taylor Spinal Retractor**

- **7 1/4" (18.5 cm)**  
WR-47-70 1 1/4" x 3" blade  
**8" (20.5 cm)**  
WR-47-72 1 1/4" x 4" blade



• **Kujat Shoulder Retractor**

- **WR-07-520 30 mm blade**  
**WR-07-525 35 mm blade**



- **Murphy-Lane Bone Skid**
- **Double ended / 1 1/4" cup & 3/4" cup / 12" (30.5 cm)**  
WR-30-160



- **Aufranc Cobra Retractor**
- **10 1/2" (26 cm)**  
WR-100-82 sharp serrated tip  
WR-100-84 blunt serrated tip  
WR-100-86 blunt smooth tip  
WR-100-87 pointed smooth tip

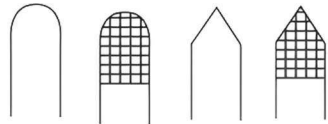

- **Warsi Stifle Thrust Lever**
- **WR-100-691 8 3/8"**  
**WR-100-692 11"**



• **Lahey Retractor**

• **Lahey Retractor**

7 3/4" (20 cm)

WR-207-30



WR-207-30

• **Hibbs Retractor**

• **Sharp teeth / 9 1/4" (23.5 cm)**

WR-207-89 25 mm w x 50 mm d

WR-207-90 26 mm w x 75 mm d

WR-207-91 mm w x 100 mm



WR-207-89

• **Malleable Ribbon Retractor**

• **Malleable**

- WR-207-54 1/4" x 7"
- WR-207-55 3/8" x 7"
- WR-207-56 1/2" x 7"
- WR-207-60 5/8" x 7"
- WR-207-61 3/4" x 7"
- WR-207-62 1" x 7"
- WR-207-63 3/4" x 13"
- WR-207-64 1" x 13"
- WR-207-65 1 1/4" x 13"
- WR-207-66 1 1/2" x 13"
- WR-207-67 2" x 13"
- WR-207-68 2 1/2" x 13"
- WR-207-69 3" x 13"
- WR-207-70 3 1/2" x 13"
- WR-207-71 4" x 13"
- WR-207-72 5" x 13"
- WR-207-74 1 3/4" x 13"
- WR-207-73 2 3/4" x 13"



WR-207-73



WR-207-67

• **Malleable Ribbon Retractor**

• **Hollow Grip Handle**

- WR-207-82 3/4" wide blade
- WR-207-84 1" wide blade
- WR-207-86 1 1/4" wide blade
- WR-207-88 1 1/2" wide blade
- WR-207-90 2" wide blade



WR-207-88



WR-207-90

• **Volkman Retractor**

• **Sharp / 4 1/2" (11.5 cm)**

- WR-100-48 2 prong
- WR-100-50 3 prong
- WR-100-52 4 prong
- WR-100-54 6 prong

**Sharp / 8" (20 cm)**

- WR-100-56 2 prong
- WR-100-58 3 prong
- WR-100-62 6 prong

**Sharp / 8 1/2" (22 cm)**

- WR-100-60 4 prong

**Blunt / 4 1/2" (11.5 cm)**

- WR-100-48B 2 prong
- WR-100-50B 3 prong
- WR-100-52B 4 prong
- WR-100-54B 6 prong

**Blunt / 8 1/2" (22 cm)**

- WR-100-56B 2 prong
- WR-100-58B 3 prong
- WR-100-60B 4 prong
- WR-100-62B 6 prong

**Sharp / 8 3/4" (23 cm)**

- WR-214-052 4 prong



WR-100-52



WR-214-052

• **Meyerding Retractor**

• **WR-207-15 large blade 3 1/2" x 2" x 9 1/2"**

**WR-207-13 medium blade 3" x 1" x 9 1/2"**

**WR-207-11 small blade 2" x 5/8" x 9 1/2"**



WR-207-11

● **Senn Retractor**

- Double-ended / 6 1/4" (16 cm)  
WR-100-68 sharp  
WR-100-68B blunt  
WR-100-68T sharp titanium



● **Senn Retractor**

- Blue electro coated / Double-ended / 6 1/4" (16 cm)  
WR-100-69 sharp  
WR-100-69B blunt



● **Ragnell Retractor**

- Double-ended / 6" (15 cm)  
WR-205-49



● **Ragnell Retractor**

- Blue coated / double-ended / 6" (15 cm)  
WR-205-49 B



• **Richardson Retractor**

• **9 1/2" overall length / loop grip handle**

WR-207-38 1" x 3/4"

WR-207-40 1" x 1 1/4"

WR-207-42 1 1/2" x 1 1/2"

WR-207-45 2" x 3/4"



WR-207-42

**9 1/4" overall length / hollow grip handle**

WR-27-333 2" x 3/4"

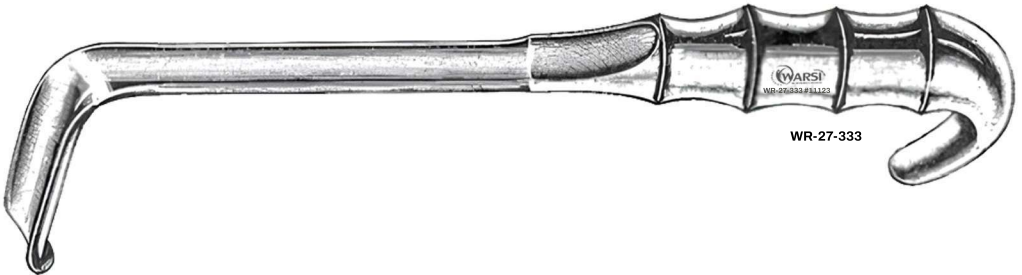

WR-27-333

**11" overall length / lamb grip handle**

WR-207-26 1" x 3/4"

WR-207-28 1 1/4" x 1"

WR-207-30 1 1/2" x 1 1/2"



WR-207-30

• **Richardson-Eastman Retractor**

- **WR-07-19-SET** set of two, one large and one small
- **WR-07-21** small 10" (25 cm)
- **WR-07-23** large 11" (28 cm)



• **Kelly Retractor**

- **Hollow grip handle / 9 1/2" (24 cm)**
- **WR-07-58** 1 1/2" x 2"
- **WR-07-60** 2" x 2 1/2"
- **WR-07-62** 2 1/2" x 3"
- **WR-07-64** 3" x 3 1/2"

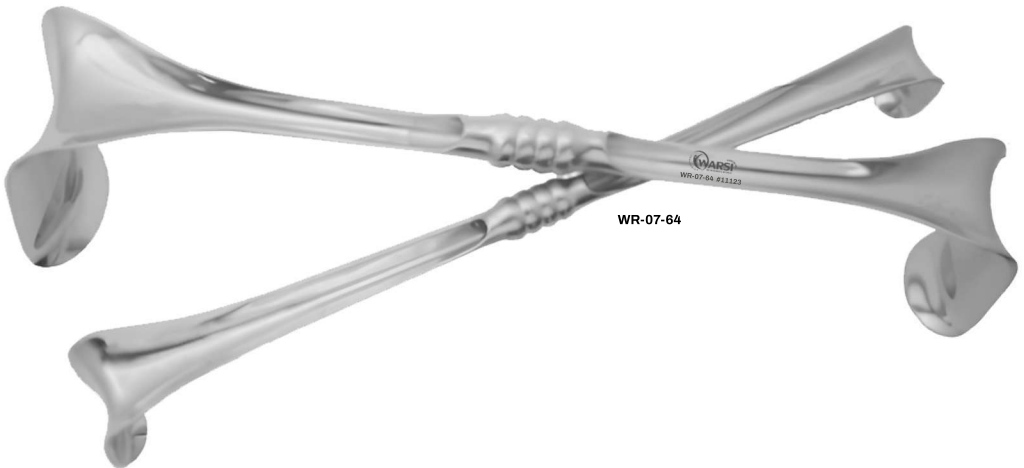

• **Kelly Lamb Retractor**

• **10" overall length**

WR-07-50 1 1/2" x 2"

WR-07-52 2" x 2 1/2"

WR-07-54 2 1/2" x 3"

WR-07-56 3" x 3 1/2"



WR-07-56

• **U.S. Army-Navy Retractor**

• **Set of 2 / 8 1/2" (21.5 cm)**

WR-100-660



WR-100-660

• **U.S. Army-Navy Retractor**

• **Set of 2 / blue electro coated / 8 1/2" (21.5 cm)**

WR-100-670



WR-07-56

• **Warsi-Hohmann Elevator Retractor**

- **Fenestrated head / 2 prong tip / curved**

WR-30-177 11 1/4" (30 cm) 22 mm tip

- **Radically curved head / sharp tip / curved**

WR-30-178 11 1/2" (30 cm) 22 mm tip

- **Fenestrated head / proximal tibia type / 2 prong tip / curved**

WR-30-179 12 1/4" (31 cm) 40 mm tip

- **Extra long 16" / radically curved head / sharp tip / curved**

WR-30-180 16" (40.5 cm)

- **Radically curved contoured head 120° / sharp**

WR-30-182 13" (33 cm) 40mm tip



WR-30-177

WR-30-178

WR-30-179

WR-30-180

WR-30-182

• **Warsi-Hohmann Elevator Retractor**

• **Extra long tip / C-shaped handle**

WR-310-71 10 1/4" 24 mm tip

**Radically curved / fenestrated head / sharp tip**

WR-310-73 10 1/4" 22 mm tip

**Radically curved / contoured head / sharp tip**

WR-310-74 12" 40 mm tip

**Extra wide tip**

WR-310-76 10 3/4" 33 mm tip



• **Hohman Elevator Retractor**

• **8 1/2" (21.5 cm)**

WR-1100-71 8 mm blade

**9 1/4" (23.5 cm)**

WR-1100-72 10 mm blade

WR-1100-73 18 mm blade

WR-1100-74 25 mm blade

WR-1100-75 43 mm blade

WR-1100-76 70 mm blade

**9 1/2" (24 cm) / with extra long tip**

WR-1100-71E 8 mm blade

WR-1100-72E 10 mm blade

WR-1100-73E 18 mm blade



• **Mini Hohman Elevator Retractor**

• **6 1/4" (16 cm)**

- WR-11-780 2.5 mm blade
- WR-11-679 4 mm blade
- WR-11-678 6 mm blade
- WR-11-680 8 mm blade

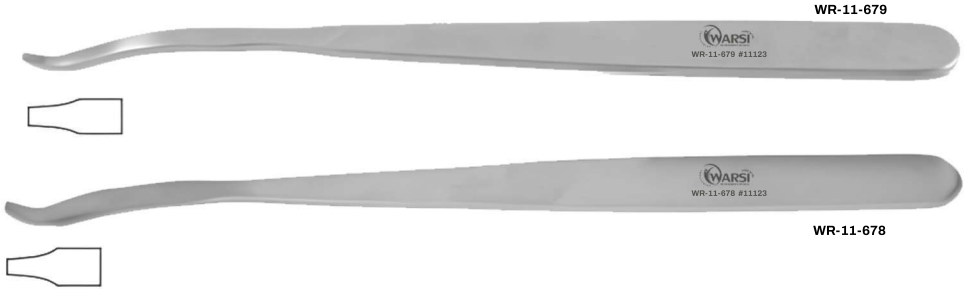

• **Warsi-Hohman Retractor**

• **Radical bend / 25 mm tip / 10 1/2" (27 cm)**

WR-11-677



• **Warsi Lane Lever Elevator**

• **Ring handle style 30-100 lbs**

WR-11-6696



- **Hip & Knee Retractor**
- **With Handle / 10" (25.5 cm)**  
**WR-27-405**



**WR-27-405**

• **Lead Hand Stabilizing Restrainer**

- **WR-49-039** pediatric 9 3/4" (25cm)
- **WR-49-040** adult 14 1/2" (37cm)



**WR-49-040**



# ORTHOPEDIC SPREADERS

• **Inge Micro Ring Handle Lamina Spreader**

- **With ratchet / 6 1/4" (16 cm)**  
WS-17-046 4x4 mm tip  
WS-17-047 1.5x4 mm tip

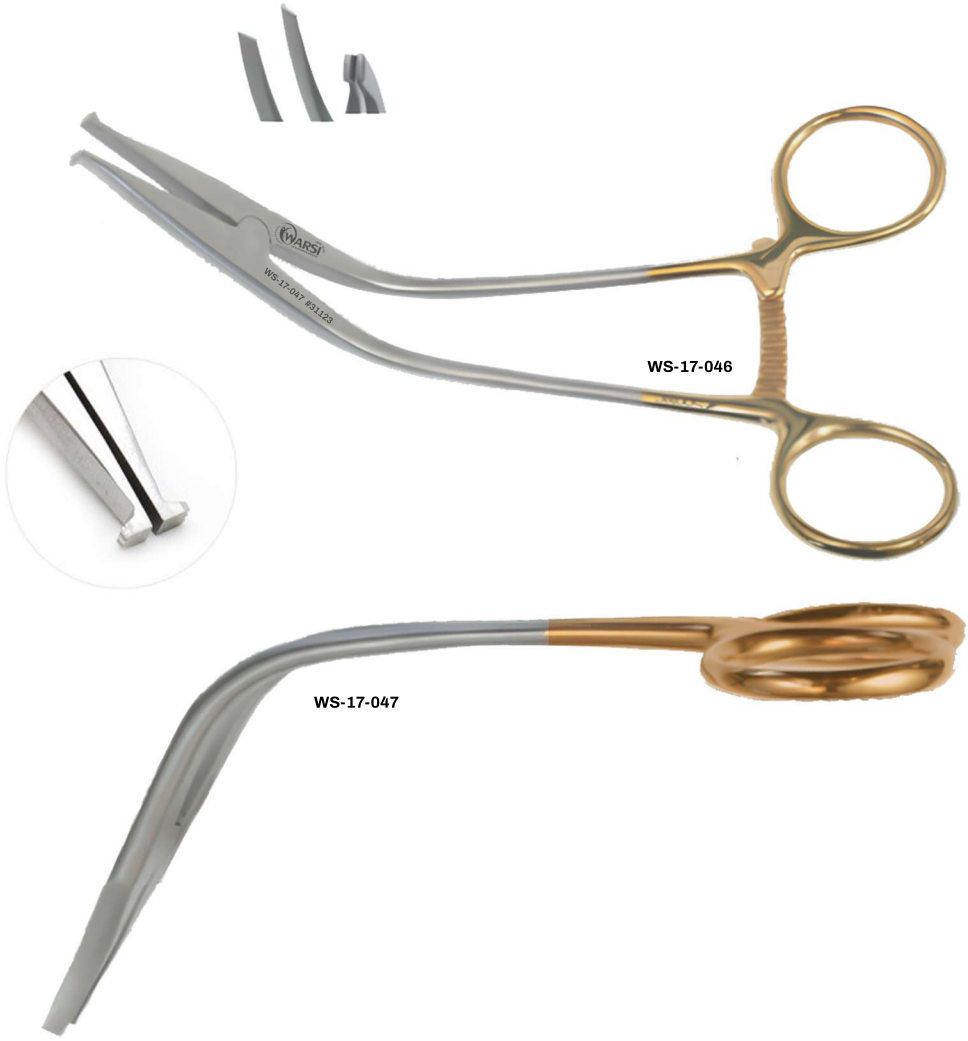

• **Joker Periosteal Elevator**

- Blunt / curved / 6" (15.5 cm)  
WS12-51  
WS12-51G



WS12-51G



WS12-51

• **Williger Periosteal Elevator**

- Sharp / 6 1/4"  
WS12-574 4 mm  
WS12-575 5 mm  
WS12-576 5 6.5 mm  
WS12-577 7 mm



WS12-574



WS12-577

• **Sayre Elevator**

- Double-ended / 6 1/2" (16.5 cm)  
WS100-512 sharp/blunt  
WS100-512B blunt/blunt



WS100-512



WS100-512B

### • **Langenbeck Periosteal Elevator**

- **Single-ended / 8" (20 cm)**  
WS35-205 narrow blunt tip 6 mm  
WS35-207 wide sharp tip 17 mm

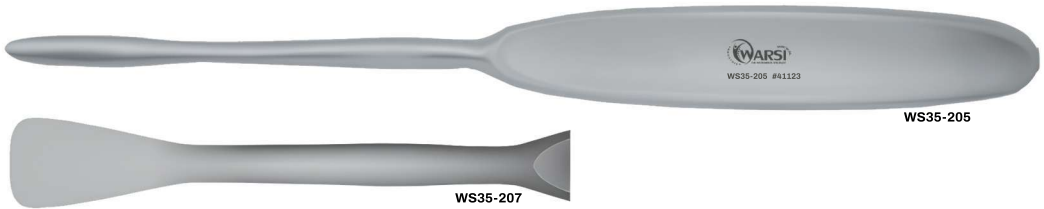

### • **Hoehn Periosteal Elevator**

- **7 mm tip / 6 1/4" (16 cm)**  
WS12-530



### • **Lane Periosteal Elevator**

- **Single-ended / 7 1/2" (19 cm)**  
WS35-210 narrow semi-sharp tip 6 mm  
WS35-212 wide semi-sharp tip 10 mm



• **McIlwraith Periosteal Elevator**

- Single-ended / 7 1/2" (19 cm)  
WS04-870 sharp  
WS04-871 sharp phenolic handle

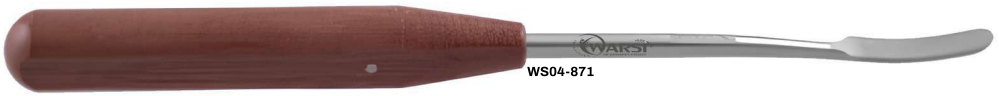

• **Key Periosteal Elevator**

- 6 3/4" (17 cm)  
WS35-135 1/8" tip  
WS35-136 1/4" tip  
WS35-137 3/8" tip



- 7 1/2" (19 cm)  
WS35-138 1/2" tip  
WS35-139 5/8" tip



- 8" (20.5 cm)  
WS35-140 3/4" tip

- 8 3/8" (21.5 cm)  
WS35-141 1" tip

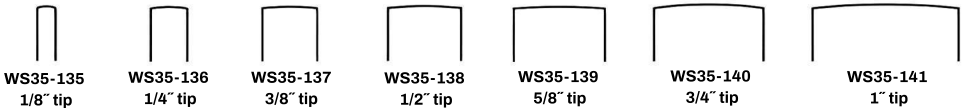

• **Scaphoid Spreader**

• **Flat & Standard Pattern**

l 14cm/5½" length

l 1 x 2 prongs

WS3-63

WS3-63A



• **Baby Inge Bone Spreader**

• **18cm/7" length**

WS3-64

7 mm  
Toothed



7 mm  
Smooth



7 mm  
Cross serrated



• **Scaglietti Lamina Spreader**

• **28cm/11" length**  
With speed lock

WS3-64S



• **Micro Inge Lamina Spreader**

- “tip D” / with speed lock  
WS17-063 micro 1 mm serrated tips  
\* also available with ratchet design



• **Inge Lamina Spreader Extra Large Retractor**

- Leverage shaped concave blades / 11" (28 cm)  
WS47-057 large 16 mm tip concave jaws  
WS47-056 small 11mm tip  
WS47-056D micro tip 1 mm tip

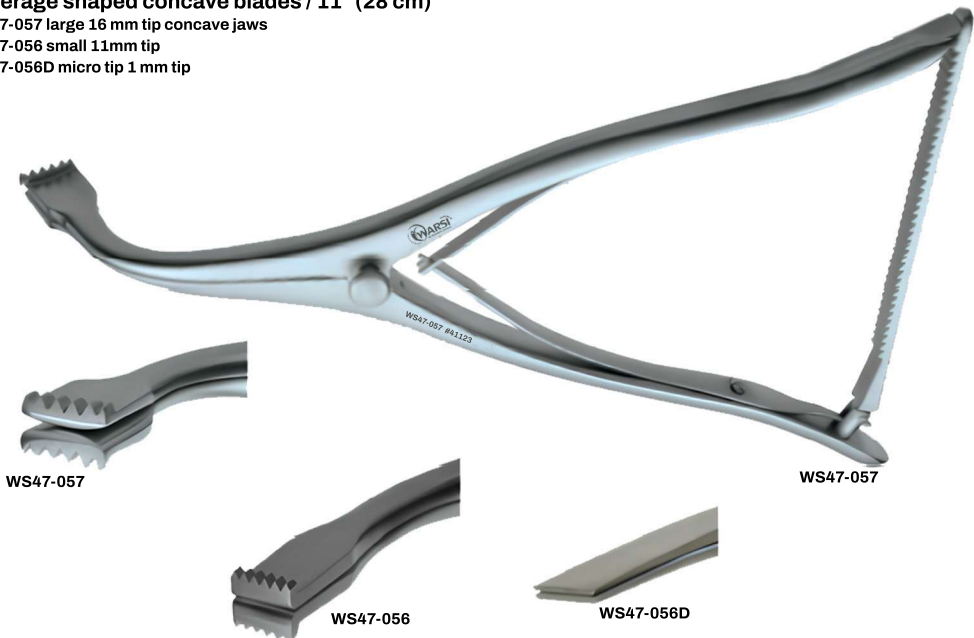

• **Piermattei Shoulder Elevator**

- **Single-ended / 9" (23 cm)**  
**WS-103-210**  
**WS-103-210G**



WS-103-210G



WS-103-210

• **Sedillot Elevator**

- **18 mm tip / 7 1/2" (19 cm)**  
**WS-35-226**  
**WS-35-226G**



WS-35-226



WS-35-226G

• **Platypus Micro Inge Lamina Spreader**

- Platypus tip / 7" (17.8 cm)  
WS-17-049



WS-17-049

• **Inge Lamina Spreader**

- With unique selection of tips / adult size / 9 1/2" (24 cm)

WS17-060 standard tip

WS17-060A tip A

WS17-060B tip B

WS17-060C tip C

WS17-060D tip D

WS17-060E tip E



417-060A



• **Trethowan Bone Elevator**

- 22.5cm/8½" length  
WS030-22  
WS030-22A



• **Lanes Bone Elevator**

- 26cm/10" length  
WS031-26  
WS031-27 Up Side  
WS031-27G



• **Inge Lamina Spreader**

• **Classic jaws / with speedlock**

WS-41-055 3.5" working length 10 3/4" overall length

WS-41-055L 5" working length 12" overall length

WS-41-055S 1.5" working length 8" overall length

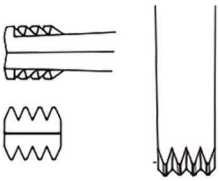

• **Inge Lamina Spreader**

- **With unique selection of tips / pediatric / 6 1/2" (16.5 cm)**

WS17-064 standard tip

WS17-064A tip A

WS17-064B tip B

WS17-064C tip C

WS17-064D tip D micro tip 1mm wide

WS17-064E tip E smooth

WS17-064F flat delicate, cross

serrated tips with calibrated ratchet

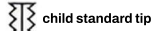

417-064D  
Fine Serrations



417-064C



417-064B



417-064A

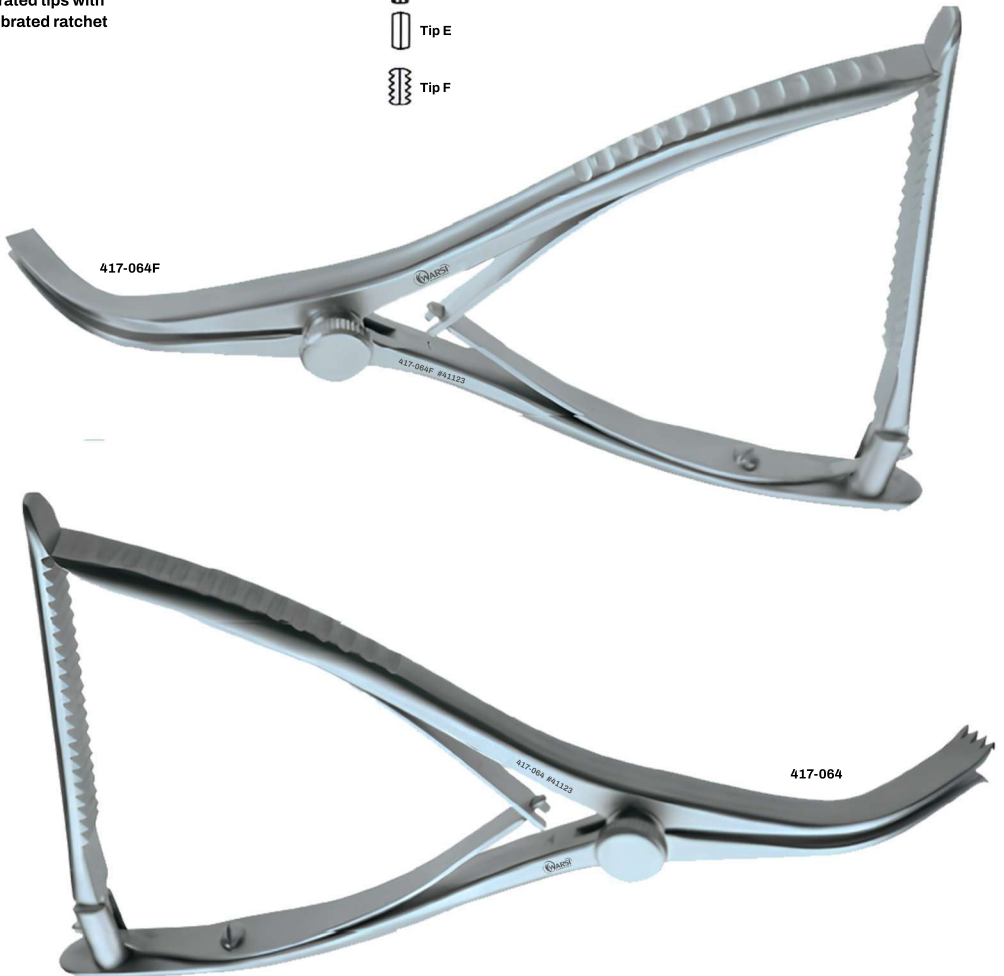



# ORTHO RODE HOLDER & BEND



• **Rod Holder Kern Type**

- With ratchet / 10" (25.5 cm) / round jaw, with threaded hole / holds rods up to 6 mm

RH-55-222

- Prism jaw / holds rods 5 mm & 5.5 mm

RH-55-223

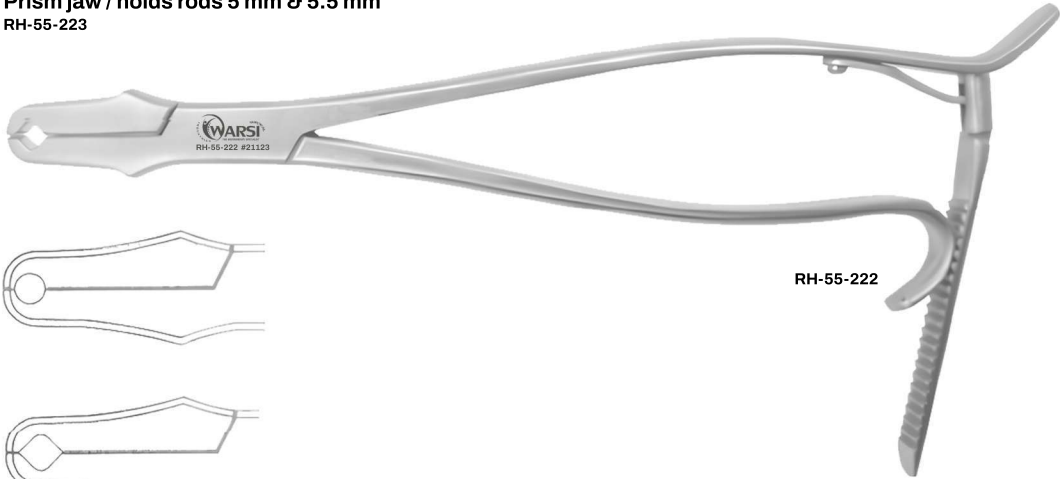

RH-55-222

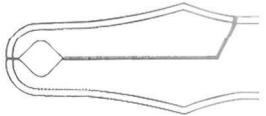
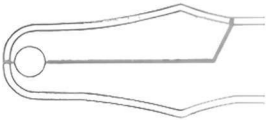

• **Ferris Smith Rod Holder**

- For Ø 5.5 rods / 7" (17.8 cm)

RH-55-226



RH-55-226

• **Mini Rod Holder**

• **7" (17.8 cm)**

RH-55-213 5.5 mm

**8 1/4" (21 cm)**

RH-55-21 2.5 mm

RH-55-215 5.5 mm

**8 3/4" (22 cm)**

RH-55-214 5.0 mm

RH-55-217 5.5 mm



RH-55-215

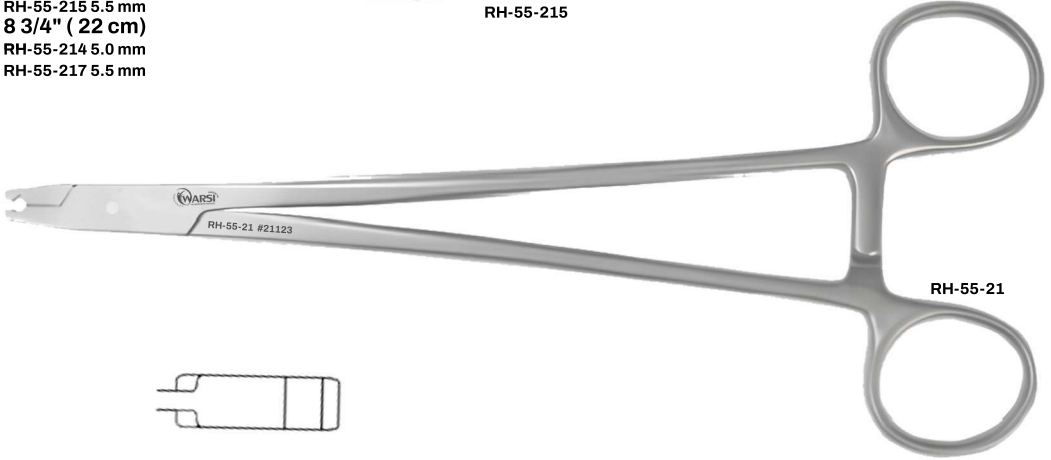

RH-55-21

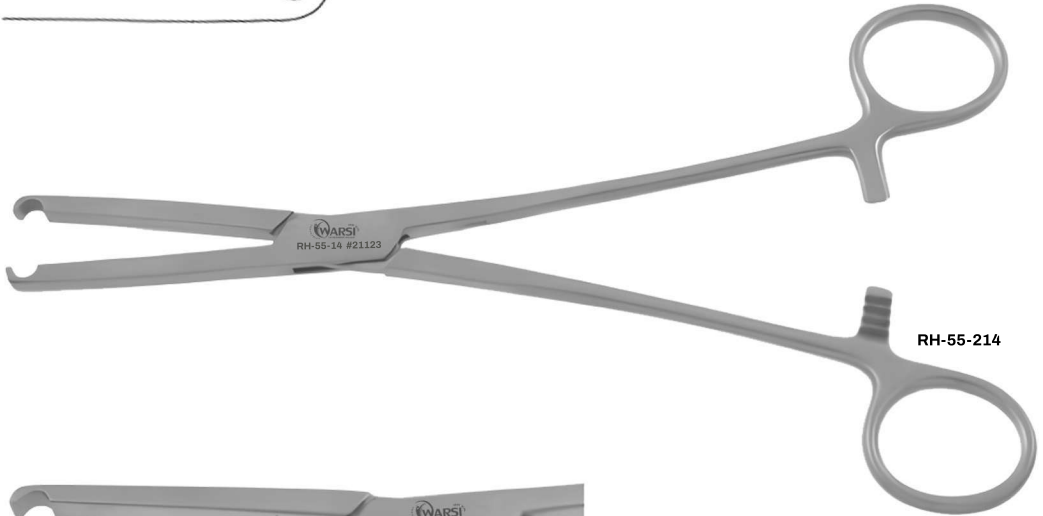
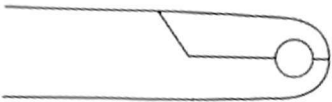

RH-55-214



RH-55-217

• **Rod Gripping Pliers**

- Adjustable to accommodate all Rod sizes / 8 3/4" ( 22cm)  
RH-103-134



RH-103-134



RH-103-134



RH-103-134

• **Wire Bender**

- **Bends and stabilizes K-wire / cuts wire up to 1.6 mm / 7 1/2" (19 cm)**

RH-103-15K  
RH-103-15T



• **Rod Bender Small**

• **Double sided / 7" (18 cm)**

RH55-238 fits 3mm and 4mm rods

RH55-239 universal 3mm and 4mm rods

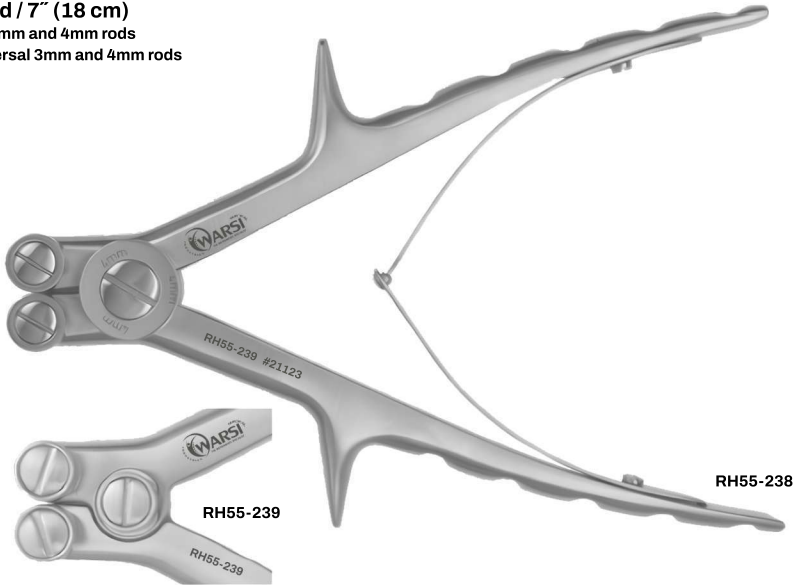

• **Rod Bender Large**

• **11" (28 cm)**

RH55-240 bends rods up to 7 mm

RH55-241 bends rods up to 5.5 mm



• **Aderer Wire Bending Pliers**

• **5 3/4" (14.5 cm)**  
RH-103-20



RH-103-20

• **Waldsachs Universal Pin Bender Pliers**

• **6" (15 cm)**  
RH103-38  
RH103-81 TC

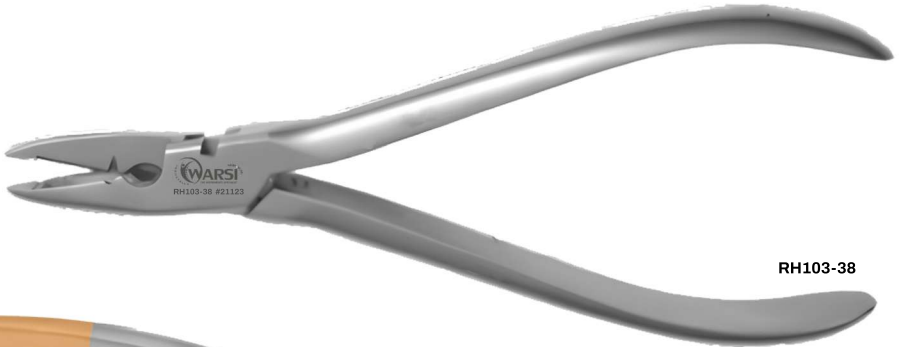

RH103-38



RH103-81



# ORTHOPEDIC SCREWDRIVERS

• **Hexagonal Screw Driver**

• **Screw drivers / phenolic handle**

- SD106-261 2.5 mm 7" (18cm)
- SD106-263 3.5 mm 7" (18 cm)
- SD106-270 2.5 mm 7 3/4" (20 cm)
- SD106-260 2.5 mm 9" (23 cm)
- SD106-262 3.5 mm 9" (23 cm)
- SD106-271 2.5 mm 9" (23 cm)

**Universal screw driver sleeve**

SD106-270S



SD106-263



SD106-270S



sleeve and screw drivers sold separately

**Phenolic handle / 10 1/2" (27 cm)**

SD106-257 2.5mm screw driver w/ sleeve

SD106-258 2.5mm screw driver

SD106-259 sleeve



SD106-258



SD106-259



SD106-257

• **A.O. Type Universal Screw Driver**

• **Screw drivers / 5" (13 cm)**

- SD-1106-0 AO type tap handle
- SD-1106-1 AO type tap handle swive

**Screw driver shaft**

- SD-1106-283 1.5 mm
- SD-1106-285 2.5 mm
- SD-1106-284 3.5 mm



SD-1106-1



SD-1106-285



1106-281 with 2.5mm shaft and  
universal sleeve

• **Lubra® Screw Driver**

• **Phenolic Handle / 6 3/4" (17 cm)**

- SD106-65 flat head
- SD106-67 hex head

**Phenotic handle / 10" (25 cm)**

- SD1106-26 single slot
- SD1106-27 cruciform
- SD1106-28 phillips



SD1106-65

• **Omega Mini Screwdriver Set**

• **SD-106-271 Set includes:**

SD-106-487 Omega mini screwdriver round handle 4" (10.2 cm)

SD-106-489A 1.5mm hex screw driver shaft 2" (5 cm)

SD-106-489B 1.5mm cruciform hex screw driver shaft 2" (5 cm)

SD-106-489C sleeve for cruciform hex mini screw driver shaft 1.5 mm



sleeve and screw drivers sold seperatly



- **AO Type Universal Screwdriver Set**

- **SD-106-2881 Set includes:**

SD-106-88 AO type tap handle swivel 4 1/4" (11 cm)

SD-106-89A 1.5mm hex screwdriver shaft 2" (5 cm)

SD-106-89B 1.5mm cruciform hex screwdriver shaft 2" (5 cm)

SD-106-89C universal sleeve mini screwdriver shafts 1.5 mm



sleeve and screw drivers sold separately



• **Slotted Head**

• 17cm/6¾" length

For head screws 2.7mm - 4.0mm

SD-714-17



SD-714-17

• **Long Slotted Head**

25cm/10" length

For head screws 2.7mm - 4.0mm

SD-014-25



SD-014-25

• **Phillips Head**

25cm/10" length

For small Phillips head screws 6mm

SD-015-25



SD-015-25

- **Cross Slotted Head**
- 25cm/10" length  
For cross slot screws 6mm  
SD016-25K

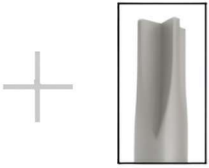

- **Hexagonal Head**
- 25cm/10" length  
For hexagonal head screws 2.7mm - 4.0mm  
SD016-25L



2.5mm Hex  
SD016-28L  
For 2.7mm to 3.5mm screws

3.5mm Hex  
SD016-30L  
For 4.5mm to 6.5mm screws

- **Screwdriver Handle**
- To fit shafts with quick lock attachment

SD720-02



SD720-02

### Screwdriver Handle Small

To fit shafts with quick lock attachment

SD020-01



SD020-01

### Shaft with Quick Lock Fitting

Hexagonal tip

Shaft Diameter

SD7-00 2.5mm

SD8-00 3.5mm



SD8-00



# ORTHO DRILLS, GUIDE & CHUCK

• **Sontec I.M. Pin Chuck**

• **Stainless steel keyed drill chuck**

WD03-290 3/8"  
WD03-291 5/16"

**Key for Sontec I.M. pin chuck**

WD03-285K for 3/8" chuck  
WD03-284K for 5/16" chuck



WD03-291



WD03-290



WD03-284K



WD03-285K

• **Sontec Hybrid I.M. Pin Chuck**

• **Stainless steel universal use with or without key drill chuck**

WD03-293 3/8"

**Key for 3/8" hybrid chuck**

WD03-293K



WD03-293



WD03-293K

- **Sontec I.M. Pin Chuck Extensions**
- **WD03-187 extension handle to protect against sharp end of pin being exposed**
- **WD03-186X key extension handle for IM Pin chuck key leverage device**



WD03-186X



WD03-187

• **Kirschner Wire Introducing T-Handle**

- 12cm/4¾" length
- 1.5mm Ø wires

DA015-12



DA015-12

• **Steinmann Pin Introducer T-Handle**

- 14cm/5½" length
- 0.5mm - 8mm Ø pins
- With Jacobs chuck & key

DP502-14



DP502-14

• **Steinmann Pin Introducer T-Handle**

- 14cm/5½" length
- 0.7mm - 6mm Ø pins
- Universal chuck

DP507-14



DP507-14

- **Warsi Keyless I.M. Pin Drill Chuck**

- **Stainless steel chuck with lock system**  
WD103-194 3/8"



WD103-194

- **Warsi I.M. Pin Chuck Aluminum Handle**

- **WD103-190H for 3/8" chuck**  
WD103-191H for 5/16" chuck



WD103-190H

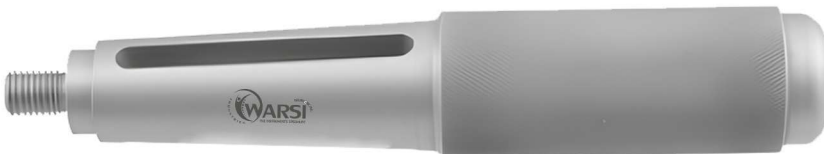

WD103-191H

- **Warsi I.M. Pin Chuck T-Handle**

- **Stainless steel chuck with lock system**  
WD103-185T



WD103-185T

- **Power Drill Adapter for Warsi I.M. Pin Chuck**

- **For 5/16"**  
WD103-176



WD103-176

• **Warsi I.M. Pin Chuck Set**

• with aluminum handle

WD103-184 SET

**Set includes:**

- WD103-191 stainless steel 5/16" chuck
- WD103-184K key
- WD103-191H aluminum handle
- WD103-187 extension handle
- WD103-185-SET

**Set includes:**

- WD103-190 stainless steel 3/8" chuck
- WD103-185K key
- WD103-190H aluminum handle
- WD103-187 extension handle



WD103-184

• **Warsi I.M. Pin Chuck Set**

• with t-handle

WD103-184T-SET

**Set includes:**

- WD103-191 stainless steel 5/16" chuck
- WD103-184K key
- WD103-185T t-handle
- WD103-185T-SET

**Set includes:**

- WD103-190 stainless steel 3/8" chuck
- WD103-185K key
- WD103-185T t-handle



WD103-184T

• Warsi Hybrid I.M. Pin Chuck Set

• with aluminum handle

WD103-193-SET

**Set includes:**

WD103-193 stainless steel 3/8" keyed or keyless drill chuck

WD103-193K key

WD103-190H aluminum handle

WD103-187 extension handle  
with t-handle

WD103-193T-SET

**Set includes:**

WD103-193 stainless steel 3/8" keyed or keyless drill chuck

WD103-193K key

WD103-185T t-handle



WD103-193

• Warsi Keyless I.M. Pin Chuck Set

• with aluminum handle

WD103-194-SET

**Set includes:**

WD103-194 stainless steel 3/8" keyless chuck

WD103-190H aluminum handle

WD103-187 extension handle  
with t-handle

WD103-194T-SET

**Set includes:**

WD103-194 stainless steel 3/8" keyless chuck

WD103-185T t-handle

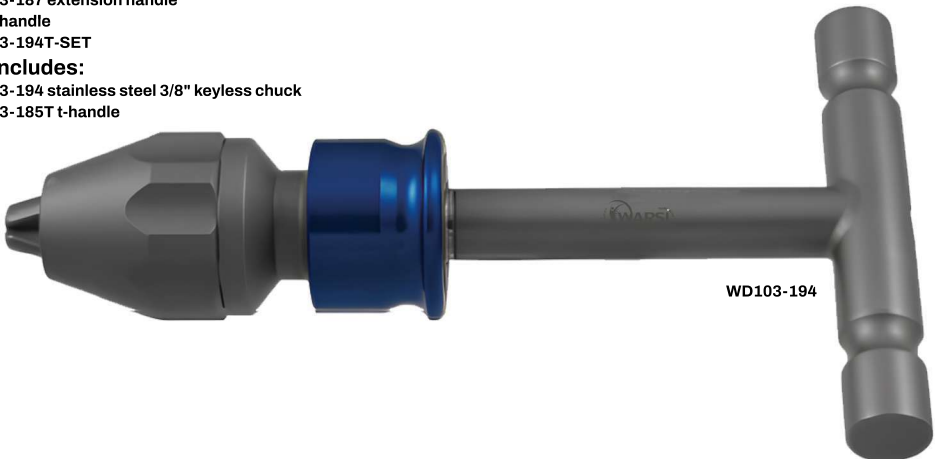

WD103-194

• **K-Wire Pin Driver**

- **Cannulated for K-wire / 6 3/8" (15.5 cm)**

WD103-180

WD103-180T titanium



WD103-180



WD103-18T

• **Universal Drill Guide**

- **With adjustable spiked head and 3 different sized interchangeable guide tubes**

WD103-168 SET

**Set include:**

WD103-168 Universal Drill Guide body with spike

WD103-16820 2.0 mm guide tube

WD103-16827 2.7 mm guide tube

WD103-16835 3.5 mm guide tube

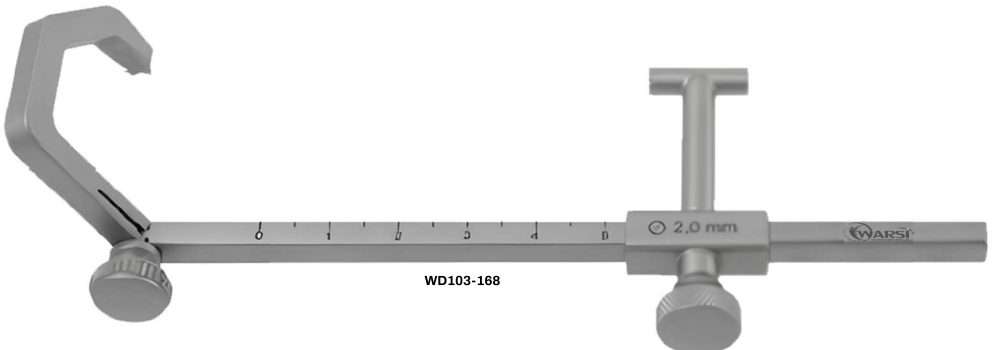

WD103-168

• **Tap Sleeve & Insert Drill Sleeve Set**

- **WD103-162S-SET set includes:**  
 WD103-161 Taylor Universal drill guide handle  
 WD103-162A tap sleeve 4.5 mm  
 WD103-162B insert drill sleeve for 3.2 mm

\* The toothed tip prevents slipping on the bone



WD103-162S

drill sleeve  
spacer



WD103-162B

WD103-161

WD103-162A

• **3 / 1 Drill Guide**

- **For drill 2 mm / double ended**  
 WD103-162C tap sleeve 4.5 mm



WD103-162C

• **Tap/ Drill Sleeve**

• **Double ended**

WD103-162D 3.5 mm x 2.5 mm  
WD103-162E 2.7 mm x 2.0 mm



• **Micro Tap/ Drill Sleeve**

• **2.5 mm / single ended**

WD103-162M



• **Taylor Drill Guide**

• **WD103-165 small reducer 3.2 mm / 1.6 mm**

WD103-166 large reducer 7 mm / 3.2 mm

WD103-167 handle / reducer 9.5 mm / 7 mm



• **Countersink Bit Cannulated**

- **WD106-84 3.5 / 4.0 mm screws**
- **WD106-85 4.5 mm screws**



• **Measuring Gauge**

- **For cannulated screws / 3.5 mm & 4.5 mm**
- **WS106-75**



• **AO Tap Cannulated**

- **WD106-87 for 4.5 mm screws 7"**
- **WD106-88 for 3.5 mm screws 4 1/4"**



• **Drill Bit Quick Coupling**

- **4.5 mm Ø 195 mm**
- **WD106-91**



• **Double Drill Guide**

- 4.5 / 3.2 mm  
WD03-624



WD03-624

• **Double Drill Guide**

- 2.7 / 1.25 mm  
WD03-625



WD03-625

• **Parallel Drill Guide**

- For 1.6 mm wire / 4.5 mm cannulated screws  
WD03-622 small reducer



WD03-622

• **Bone Tunnel Borer**

- 7" (18 cm)
- WD06-48 2.7 mm



WD06-48

\* Stainless Steel, small handle, attached drill bit. Used to create bone tunnel quickly and easily without having to set upon a complete orthopedic drill.

• **Valkyrie Mach Holder / Drill Guide**

- WD03-601



WD03-601



**ORTHOPEDIC SPECIALITY**

• **Depth Gauge**

- 6 1/4" (16 cm) /  
Screw size 2.4 - 4.0 /  
10 mm - 60 mm  
WT55-162
- 8 3/4" (22 cm) /  
Screw size 3.5 - 6.5 /  
10 mm - 90 mm  
WT55-163
- 10 mm - 120 mm  
WT55-163L



**1.) Scale**

**a.) Scolo gradations**

Please Mark Your Desired Scale Design

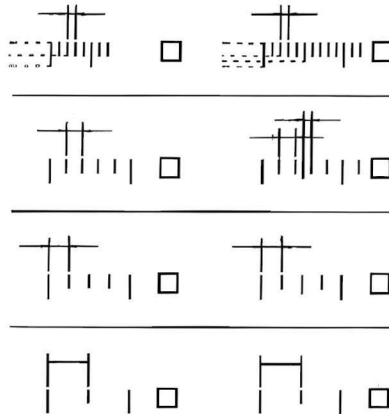

**b.) Lenght of scale .....mm**

c.) customized scale please add your Drawing .....mm

**2.) Distance dimension of zero-point to the lip distance**

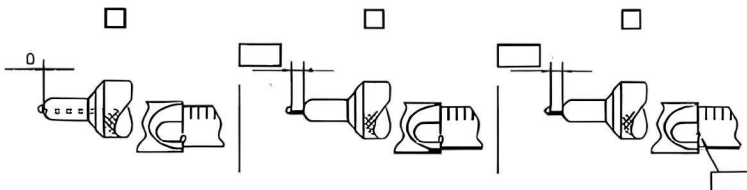

- **Mini Depth Gauge**

- Screw size 1.5 / 10 mm - 30 mm

WT55-161



- **Taylor Micro Arthroscopic Pick**

- Straight / 1.2 mm / 8" (20 cm)

WT271-120



- **T-Handle Bone Hook**

- T-shaped phenolic handle / sharp tip / 7" (18 cm) shaft

WT20-936



• **Bone Scraper Set**

- Includes bone grater attachment 1.0 mm / 1.5 mm / 2.0 mm / 11" (28 cm)

WT55-272 two legs

WT55-273 four legs

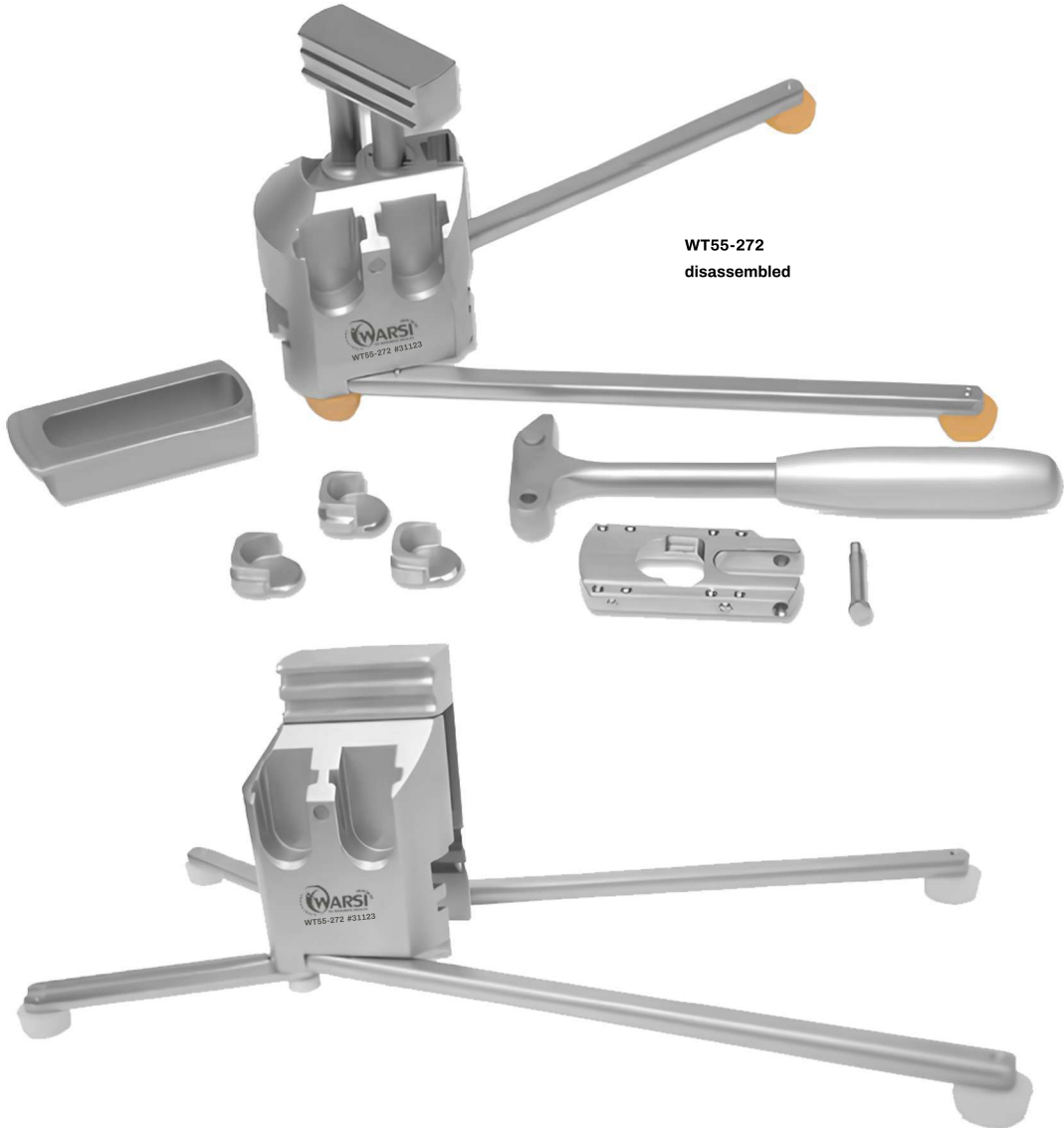

WT55-272  
disassembled

• **Liska Awl**

- T-handle / 3" shaft
- WT1271-32



WT1271-32

• **Perthes Awl**

- 6" (15 cm)
- WT1271-30



WT1271-30

• **Daniel Nasal Awl**

- 6 1/4" (10.8 cm)
- WT467-414



WT467-414

• **Warsi 3 Prong Cast Spreader**

- 9" (23 cm)
- WT20-700



• **Henning Cast Spreader**

- 10 3/4" (23 cm)
- WT40-95



• **Lumbar & Cervical Impactor**

- **WT335-190** 6.5 mm x 11.5 mm 8 1/2" (21.6 cm)
- **WT335-191** 6 mm x 12.55 mm narrow 8 3/4" (22.2 cm)
- **WT335-192** 4.3 mm x 10 mm micro lateral offset without heel 7" (17.8 cm)
- **WT335-193** 4.3 mm x 10 mm micro lateral offset with heel 7" (17.8 cm)
- **WT335-196** 10 mm x 13 mm micro lateral offset 8 3/4" (22.2 cm)
- **WT335-197** 7 mm x 12.5 mm guarded micro lateral 8 3/4" (22.2 cm)
- **WT335-198** 10 mm x 13 mm lateral wide 8 3/4" (22.2 cm)
- **WT335-199** 7 mm x 12.5 mm lateral wide 8 3/4" (22.2 cm)



WT335-190



WT335-191



WT335-193

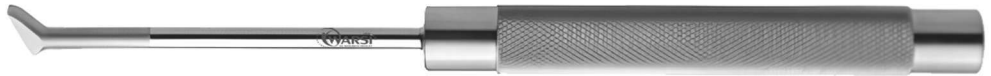

WT335-192



WT335-196



WT335-197



WT335-198



WT335-199

• **Hibbs Bone Chip Packer**

• **Hex handle / 10" (25.5 cm)**

WT35-400 2 mm x 10 mm

WT35-404 6 mm x 10 mm

WT35-406 6 mm x 19 mm



WT35-400



WT35-404

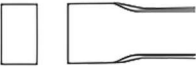

WT35-406

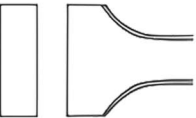

• **Lumbar Implant Holder/ Disk Marker**

• **Phenolic handle / sharp with 6mm bead tip / 12" (30.5 cm)**

WT35-380



WT35-380

• **Bone Tamp**

• **8" (20 cm)**

WT03-197A 5 mm

WT03-197B 8 mm

WT03-197C 12 mm

WT03-197D 8 mm Bent



• **Bone Mill Set**

- **WT55-270** bone mill (overall length 17")
- **WT55-275** table C-clamp for stationary positioning of bone mill
- **WT55-280** large (4.2 mm) cutting cylinder
- **WT55-285** small (3.2 mm) cutting cylinder
- **WT55-290** complete set

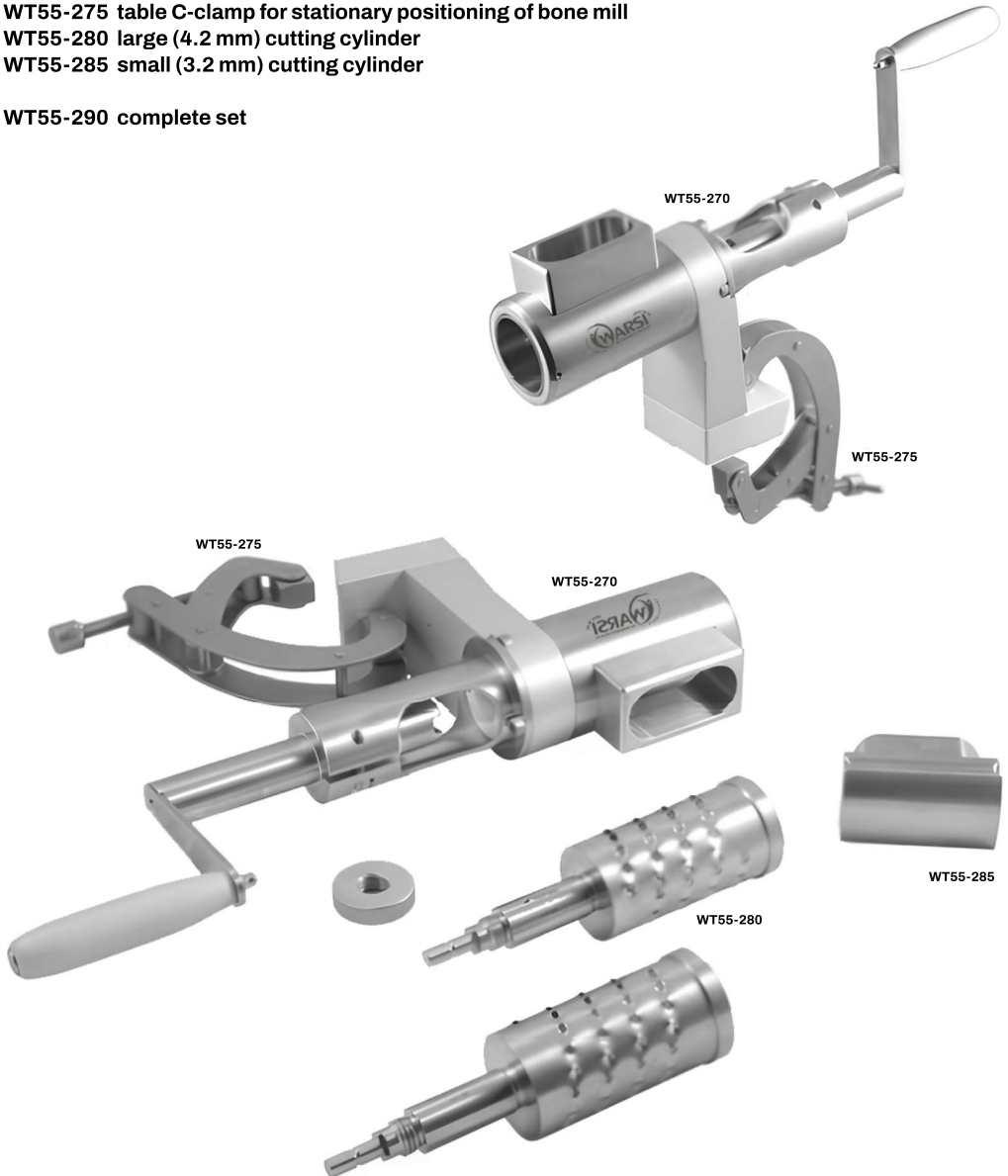



# ORTHOPEDIC TREPHINES

• **Nested Trocar Set**

• **6 1/2" (16.5 cm)**

WT-90-246 set includes:

- 6 french
- 9 french
- 13 french
- 17 french
- handle & cover



WT-90-246

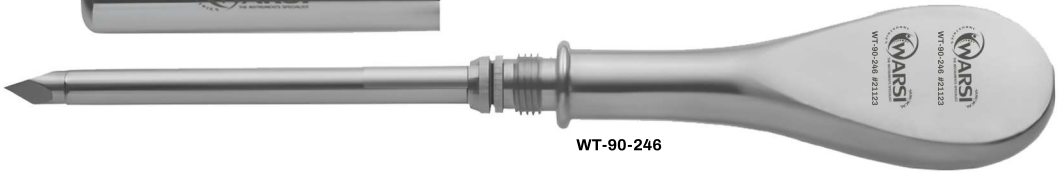

WT-90-246

• **Galt Trepine**

- **WK-419-78 1/2" / 13 mm**
- **WK-419-80 5/8" / 16 mm**
- **WK-419-82 3/4" / 19 mm**
- **WK-419-84 7/8" / 22 mm**
- **WK-419-86 1" / 25 mm**

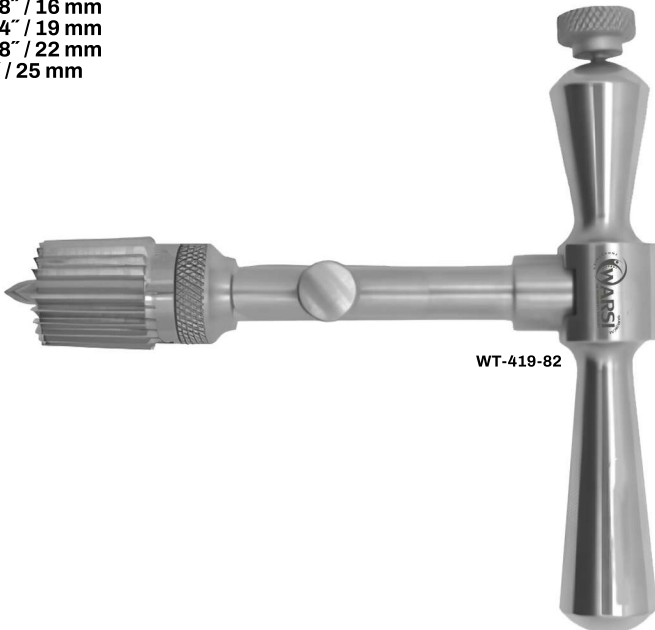

WT-419-82

• **Michele Trephine**

- **WK100-460T** 1/8" / 3 mm special diameter
- **WK100-460S** 3/16" / 5 mm
- **WK100-460M** 7/32" / 6 mm
- **WK100-460L** 5/16" / 8 mm
- **WK100-460E** 13/32" / 10 mm
- **WK100-460X** 15/32" / 12 mm

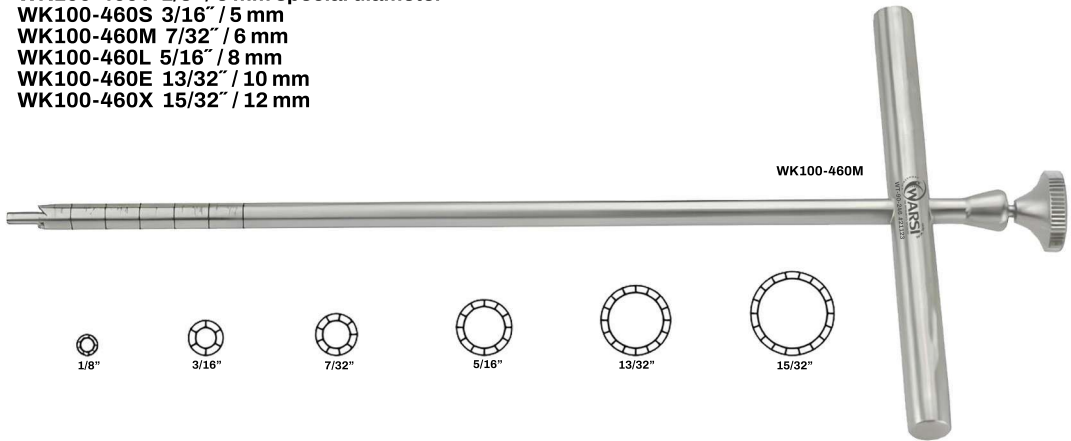

• **Shepard Ram Obturator**

- **5 1/2" (14 cm)**
- **KC94-0412** 5 mm
- **KC94-0417** 6 mm
- **KC94-0422** 8 mm



**Shepard Trocar**

- **5 1/2" (14 cm)**
- **KC94-0411** 5 mm
- **KC94-0416** 6 mm
- **KC94-0421** 8 mm

**Shepard Cylindrical Osteotome**

- **5" (13 cm)**
- **KC94-0410** 5 mm
- **KC94-0415** 6 mm
- **KC94-0420** 8 mm



**Shepard Cross Pin**

- **4 1/2" (11.5 cm)**
- **KC94-0405**



• **Plug Cutter**

- **With Obturator / 4 1/2" (11.4 cm)**  
WT-419-392 3 mm/ 5 mm
- **With Obturator / 6 1/2" (16.5 cm)**  
WT-19-393 5 mm/ 7 mm  
WT-19-394 7 mm/ 9 mm  
WT-19-395 10 mm/ 12 mm  
WT-19-396 12 mm/ 14 mm  
WT-19-397 20 mm/ 22 mm  
WT-19-398 22 mm/ 25 mm

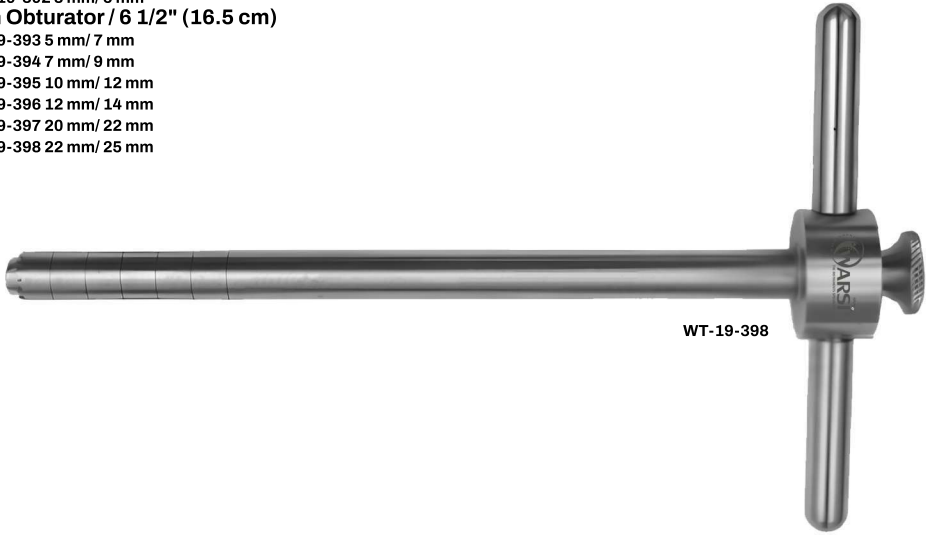

• **Bespoke Wroblewski Bone Trephine**

- **O/D 8 mm I/D 6 mm**  
WT-19-388





# ORTHOPEDIC GRIP PLIERS

• **Needle Nose Locking Pliers**

- **WG-103-37S 8 5/8" (21.75 cm)**
- **WG-103-37M 10" (25 cm)**
- **WG-103-37L 11 3/4" (29.5 cm)**

ⓘ A very useful instrument for orthopaedic surgery allowing the surgeon to securely clamp on to wires and implants



\*Pliers modified for Slap Hammer

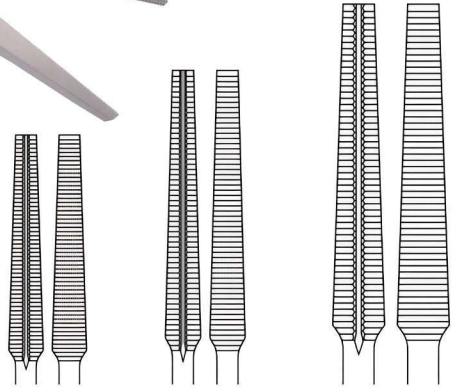

• **Slap Hammer/Hip Dislodger**

- **Modified / locking pliers / with slide hammer**
- **WG-55-300**



\*When used with slap hammer the locking pliers need modification.



• **Vise Grip Pliers**

- Locking adjustable jaws  
WG-103-13S 7" (18 cm)  
WG-103-13M 8" (20 cm)  
WG-103-13L 9 1/2" (24 cm)

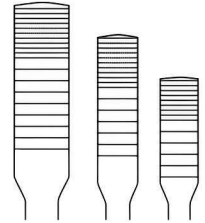

• **Slip Joint Pliers**

- Stainless  
WG-103-42 6" (15 cm)  
WG-103-41 8" (20 cm)  
WG-103-41 10" (10 cm)

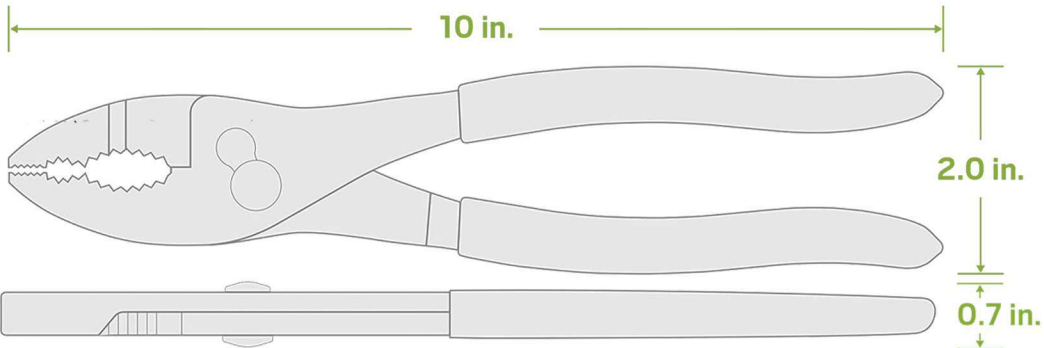

• **Needle Nose Pliers**

- **Stainless**  
WG-103-144 5 1/2" (14 cm)  
WG-103-145 6" (15 cm) delicate  
WG-106-133 7 3/4" (20 cm)



WG-103-144



WG-103-145



WG-106-133

• **Wire Extraction Pliers**

- 7" (18 cm)  
WG-106-130 cross-serrated 6 mm grooved jaw
- WG-106-131 cross-serrated 3 mm
- WG-106-132 serrated 3 m

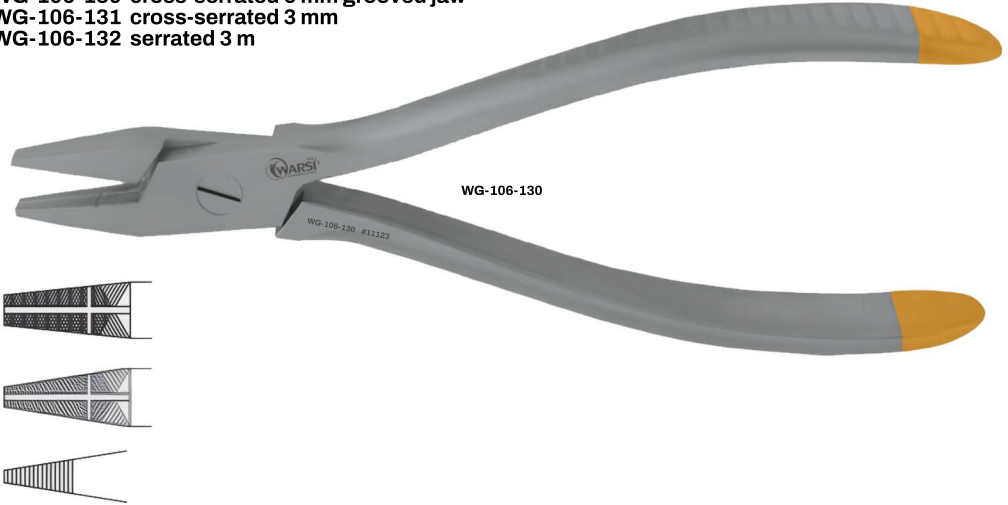

• **Pin Pulling Pliers**

- TC / one grooved jaw / 3 mm tip / 5 1/2" (14 cm)  
WG-106-14

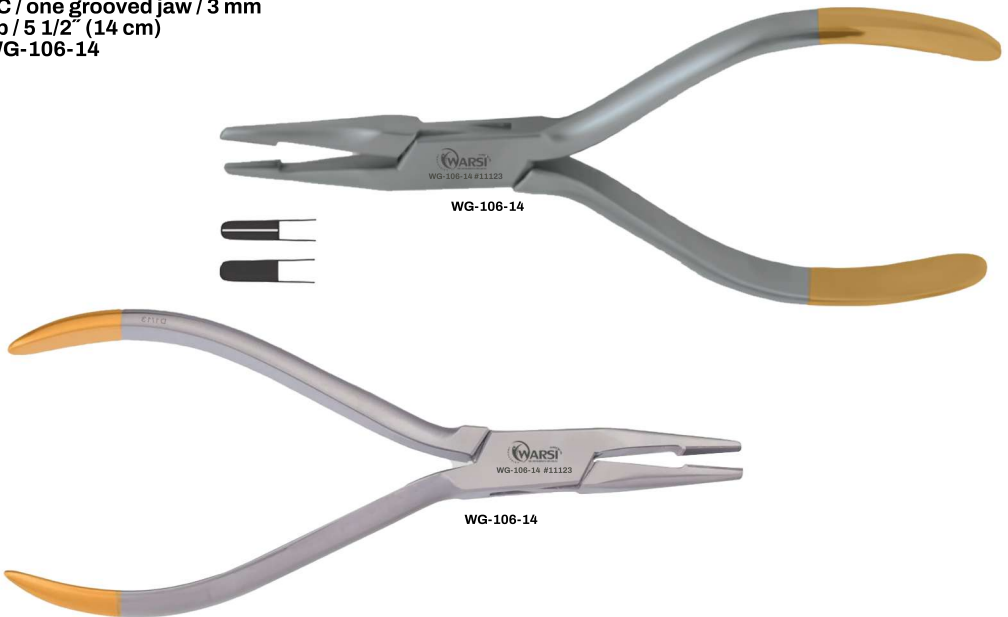



# ORTHOPEDIC WIRE PASSERS



• **Warsi Single End Wire Passer**

- Phenolic handle / 45 mm / 9" (22 cm)

WP-103-166

70 mm / 10 1/2" (27 cm)

WP-103-166X

45 mm / 8 3/8" (21.5 cm)

WP-103-167

Phenolic handle / with thick tubing wall / 9" (23 cm)

WP-103-165

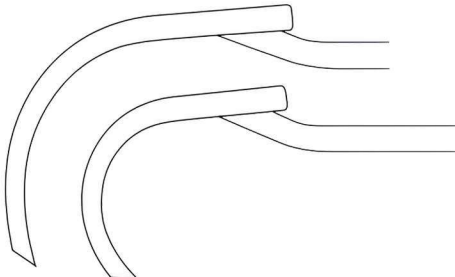
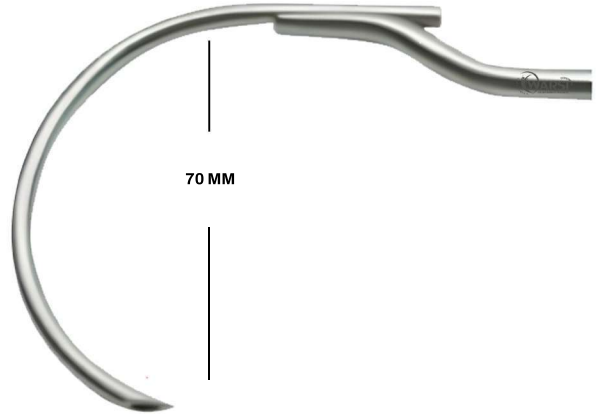

- **Hybrid Herbst Wire Passer**
- Phenolic handle / single end / 10 1/2" (26.7 cm)  
WP103-161 45mm  
WP103-162 70mm



WP103-161



WP103-162

• **Herbst-Doolen Wire Passer**

- Double-ended / small / medium / 5 1/2" (14 cm) / for 20-26 gauge wire

WP103-41



WP103-41

• **Herbst Wire Passer**

- Double-ended / 5 1/2" (14 cm) / for 18-26 gauge wire

WP103-160



WP103-160

• **Avian Mini Wire Passer**

- For 22-26 gauge wire

WP-03-48 single ended 22 gauge 4 1/2"  
WP-03-48S single ended 26 gauge 4 1/2"  
WP-03-47 double ended 22-26 gauge 5"



WP-03-48



WP-03-47



# ORTHOPEDIC WIRE PIN CUTTER

• **Wire Side Cutter**

• **TC**

PC103-15 5 3/4" (14.5 cm) cuts wire up to 1.0 mm

PC100-58 7 1/2" (19 cm) cuts wire up to 1.6 mm

PC100-58D 8" (20 cm) Deluxe cuts wire up to 1.6 mm



PC103-15



PC100-58D

- **Wire Side Cutter**
- TC / cuts wire up to 1.5 mm / 5 3/4" (14.5 cm)
- PC-103-10



- **Wire Side Cutter**
- TC / cuts wire up to 1.5 mm / 5 3/4" (14.5 cm)
- WS-103-111



• **End Pin Cutter**

- **Cannulated / cuts pins up to 1.6 mm / single action / 7 1/2" (19 cm)**

PC103-109

PC103-108 TC



PC103-108

• **Large Plate & Pin Cutter**

- **Cuts stainless steel wire & plates up to 3.5 mm / replacement jaws available / 9 1/2" (24 cm)**

PC103-104

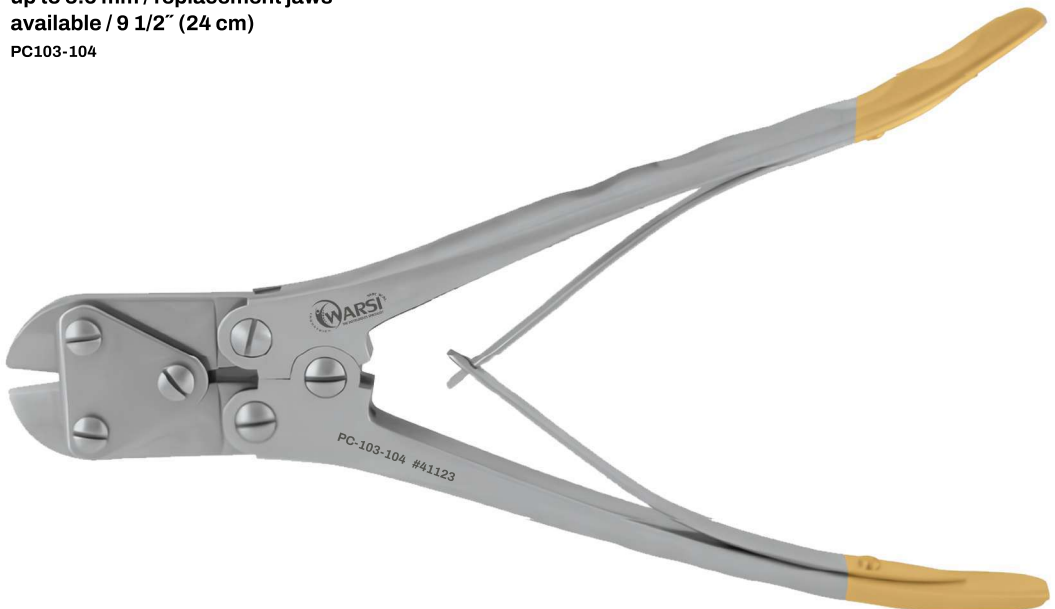

PC103-104

• **GOLD-CUT HERCULES® Pin Cutter**

- Cuts pins up to 3 mm / exchangeable TC blades / over 40% less power required / exchangeable rubber jaws / fully sterilizable / 9" (23 cm)

PC55-189 wire cutter

PC55-190 TC Blades Replacement Set

PC55-193 Rubber Jaws Replacement Set

PC55-189



• **The Big GOLD-CUT HERCULES® Pin Cutter**

- Cuts pins 2.5 mm - 4.0 mm / exchangeable TC Blades / over 40% less power required / exchangeable rubber jaws / fully sterilizable / 11" (28 cm)

PC55-191 wire cutter

PC55-192 TC Blades Replacement Set

PC55-193 Rubber Jaws Replacement Set

PC55-191



- **Baby GOLD-CUT HERCULES® Pin Cutter**
- Cuts pins up to 2.2 mm / exchangeable TC blades / over 40% less power required / exchangeable rubber jaws / fully sterilizable / 7" (18 cm)

PC55-187 left-handed

PC55-186 right-handed

PC55-188 TC Blades Replacement Set

PC55-193 Rubber Jaws Replacement Set

PC55-186

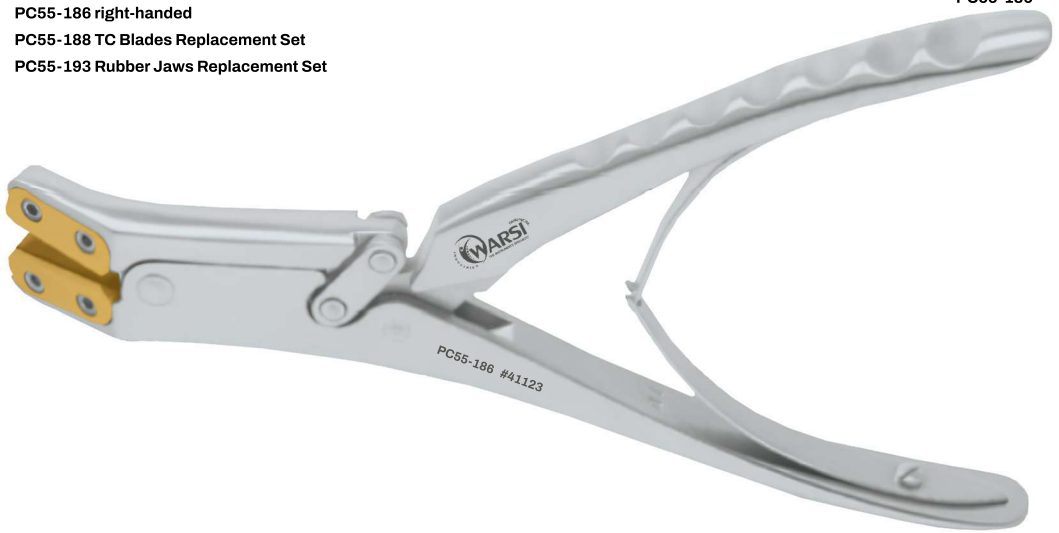

PC55-187

• **Double Action Wire Cutter**

- Cuts wire up to 1.6 mm / TC / 6 1/4" (16 cm)
- PC-00-530A

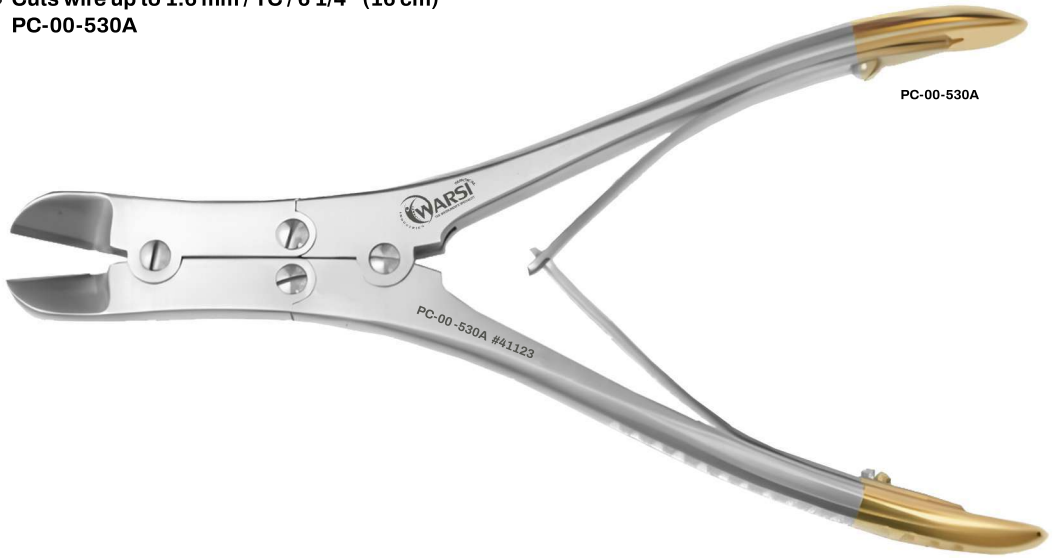

PC-00-530A

• **Micro Double Action Wire Cutter**

- Cuts wire up to 1.6 mm / TC / 6 1/2" (16.5 cm)
- PC-00-531



PC-00-531

- **Large Pin / Bolt Cutter**
- **Cuts pins up to 6.2 mm / replaceable jaws**

PC35-212 non-removable handles 22 1/2"

PC55-213 compact removable handles 18 1/2"

PC55-214 removable handles 22 1/2"

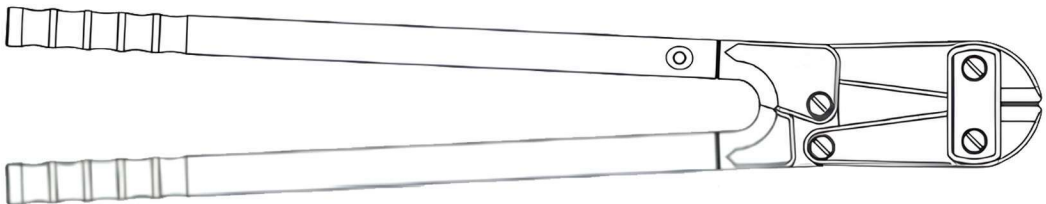
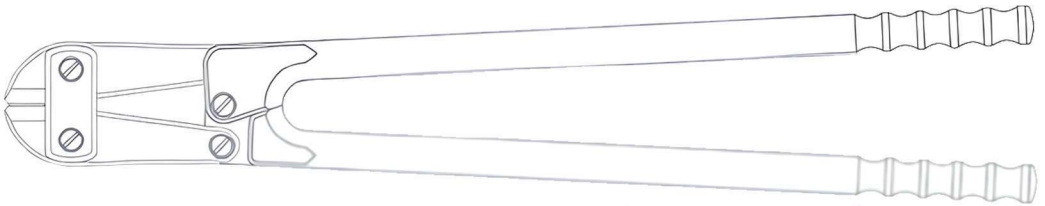
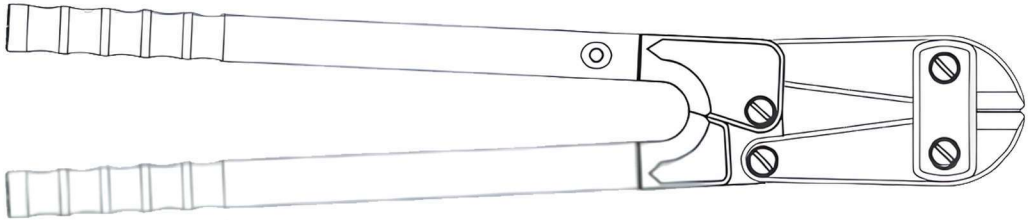

• **TC Pin Cutter**

- **Cuts pins up to 6.0 mm / replaceable jaws**

PC1103-140K 19" (48 cm) special order

PC103-140N 19" (48 cm) handles are removable  
for smaller autoclaves

PC103-140G



PC103-140G



PC103-140A



PC103-140

• **TC Pin Cutter**

- **Cuts pins up to 6.0 mm / replaceable jaws**

PC103-140 19" (48 cm) special order

PC03-140A 19" (48 cm) handles are removable  
for smaller autoclaves



• **Pin Cutter Specialty Harden Jaws**

- **Cuts pins up to 4 mm**
- PC03-140J 15" (38 cm)



• **Double Action Wire Cutter**

- **Angled to the side / TC**  
PC00-529 7 1/4" (18 cm)

Cuts wire up to 1.6 mm / TC  
PC00-530 7" (18 cm)

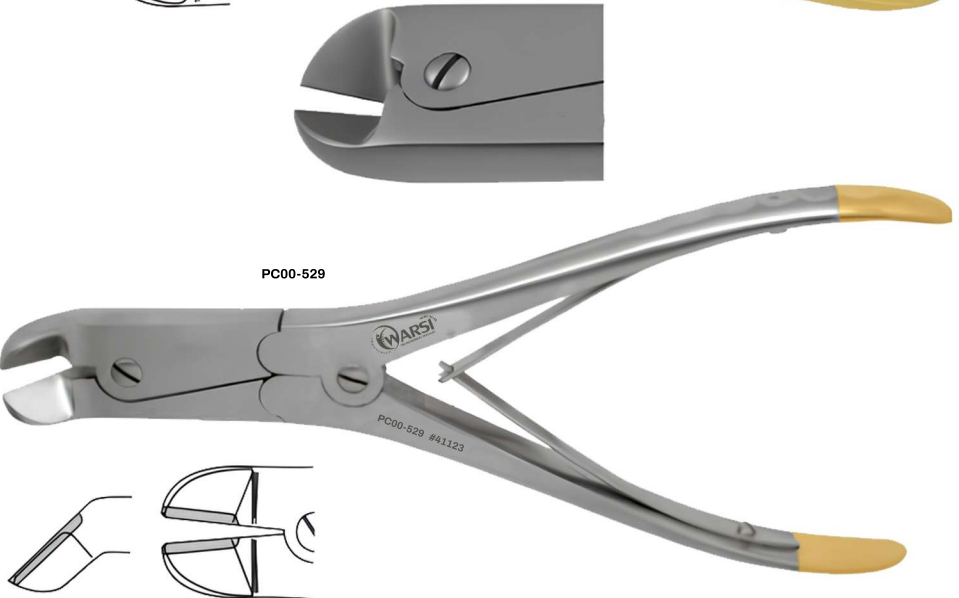
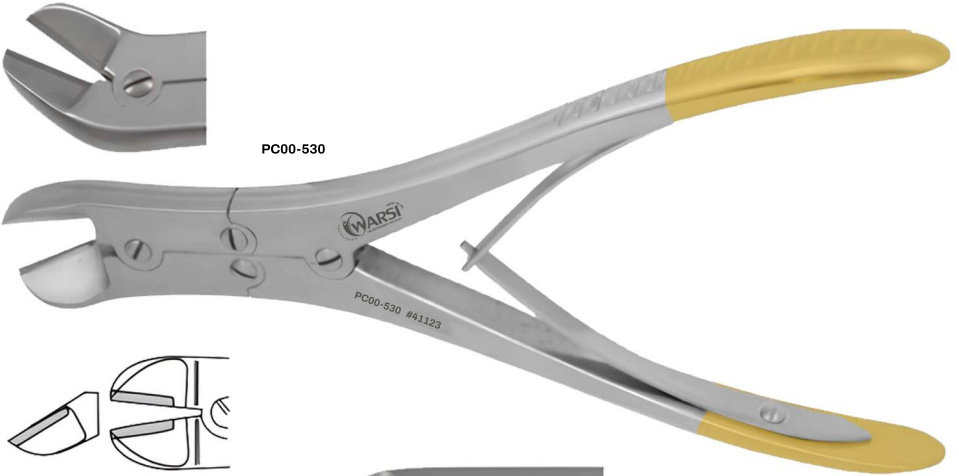

• **Warsi Pin Cutter**

- With TC inserts / max cap  $\varnothing$  4 mm / 15" (38 cm)  
PC55-209



• **Pin End Cutter**

- Cuts pins up to 3 mm / 10" (25 cm)  
PC55-202
- Cuts pins up to 4.7 mm / 14" (35.5 cm)  
PC55-210



• **Rod Cutter**

- Cuts rods  $\varnothing 2.5$  mm,  $\varnothing 3.0$  mm,  $\varnothing 3.5$  mm / 11 1/2" (29.2 cm)

PC55-207



• **Rod Flush Cutter**

- With removable handle / cuts rods  $\varnothing 4.5$  mm,  $\varnothing 5.5$  mm,  $\varnothing 6.35$  mm / 22" (57 cm)

PC55-211

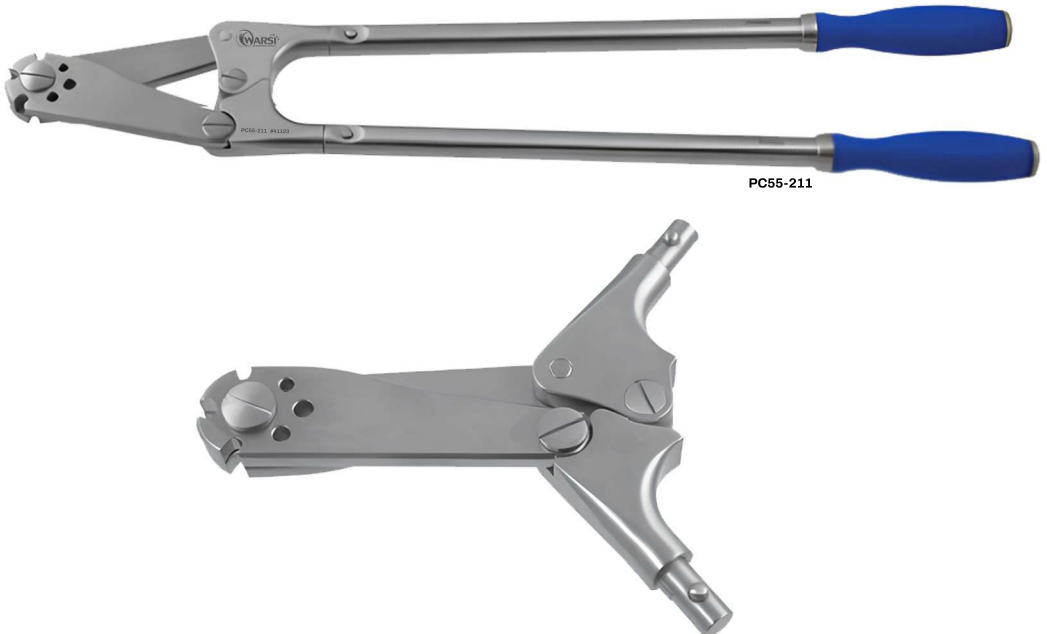

• **Wire End Cutter**

- TC / double-action / 7" (18 cm)

PC103-107



• **Flush Cut Pin Cutter**

- With enclosed cutting design / cuts pins up to 4 mm / 12" (30 cm)

PC103-117



• **Wire End Cutter**

- TC / double-action / cuts wire up to 1.5 mm / 6 1/4" (16 cm)

PC103-05 mini

- TC / double-action / Cuts wire up to 2.5 mm / 8 1/2" (21.5 cm)

PC103-00 extra large



PC103-05

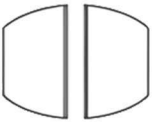

PC103-00

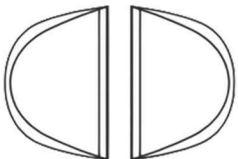

- **GOLD-CUT HERCULES® Front & Side Pin Cutter**
- Cuts pins up to 1.6 mm / over 40% less power required / exchangeable TC blades with integrated rubber jaws / fully sterilizable / 7" (18 cm)

PC55-198 front & side cutter

PC55-199 TC inserts with Rubber Jaws Replacement Set



- **TC Blades Replacement Set For Hercules Wire Cutter**

- 1 pair of TC blades / 1 pair of screws / 1 allen wrench
- PC55-190 for PC55-189  
PC55-192 for PC55-191

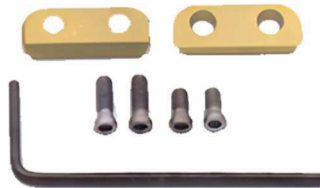

- **Rubber Jaws Replacement Set for Hercules Wire Cutter**

- 1 pair of rubber jaws / 1 pair of screws
- PC55-193 for PC55-189 and PC55-191



- **TC Inserts with Rubber Jaws Replacement Set for Hercules Front & Side Cutter**

- 1 pair of TC inserts with rubber jaws / 1 pair of screws / 1 allen wrench
- PC55-199 for PC55-198

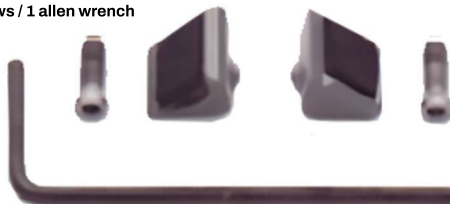



# ORTHOPEDIC WIRE TWISTER



• **Rubio Wire Twister Needle Holder**

• **Heavy / TC / 5 1/4" (13 cm)**

WT113-147



WT113-147

• **Obwegeser Wire Twister Needle Holder**

• **Special order / 5 3/4" (15 cm)**

WT230-99

WT230-99G

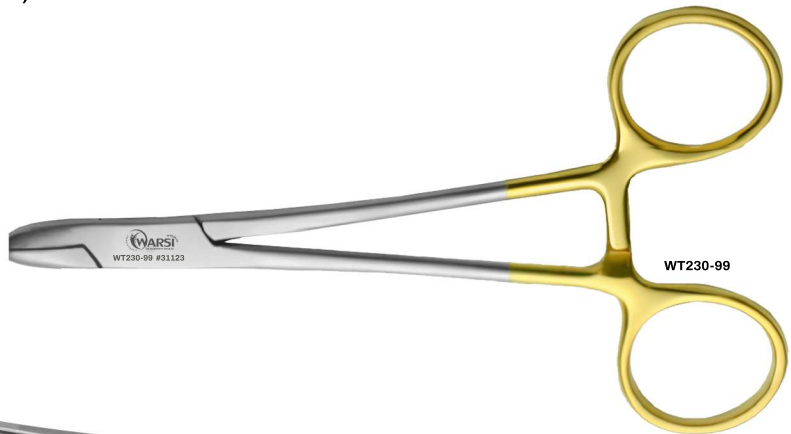

WT230-99

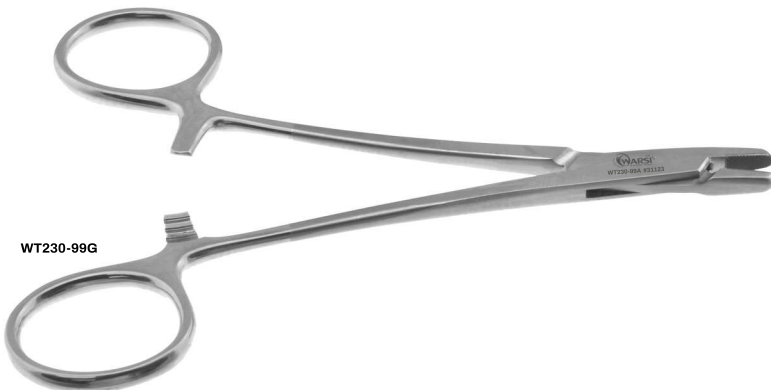

WT230-99G

- **Sternal Wire Twister Needle Holder**
- **Broad jaw / TC serrated / can be used as a wire twister / suggested suture size sternal needles and smaller**

WT-110-54S 5 1/8" (13 cm)

WT-110-52 7" (18 cm)

WT-110-53 7 3/4" (19.5 cm)

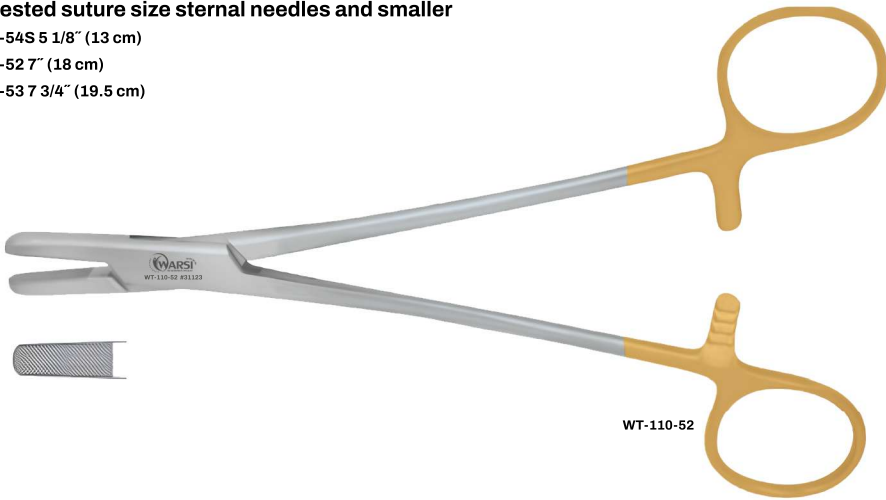

WT-110-52

- **New Orleans Wire Twister Needle Holder**
- **TC serrated / suggested suture size 2-0 and smaller**

WT230-60 rounded 6" (15 cm)

WT230-62 blunt 6" (15 cm)

WT230-61 rounded 7" (18 cm)

WT230-64 blunt 7" (18 cm)

WT230-66 rounded 8" (20.5 cm)

WT230-67 blunt 8" (20.5 cm)

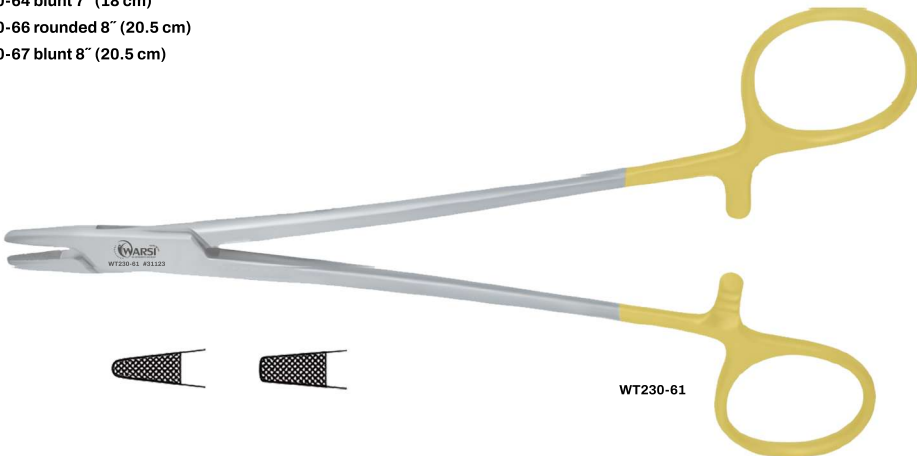

WT230-61

- **Anti-Buckle Wire Twister**
- **TC serrated / w/ guard**  
**WT-103-159 7 1/4" (18.5 cm)**



WT-103-159

- **Axel Wire Twister**
- **Needle holder style / with hole / 6 3/4" (17.1 cm)**  
WT1103-155

**Rounded jaw / with hole / heavy duty XXL**  
WT13-155 7 1/4" (18.4 cm)  
WT13-155A 8" (20.3 cm)

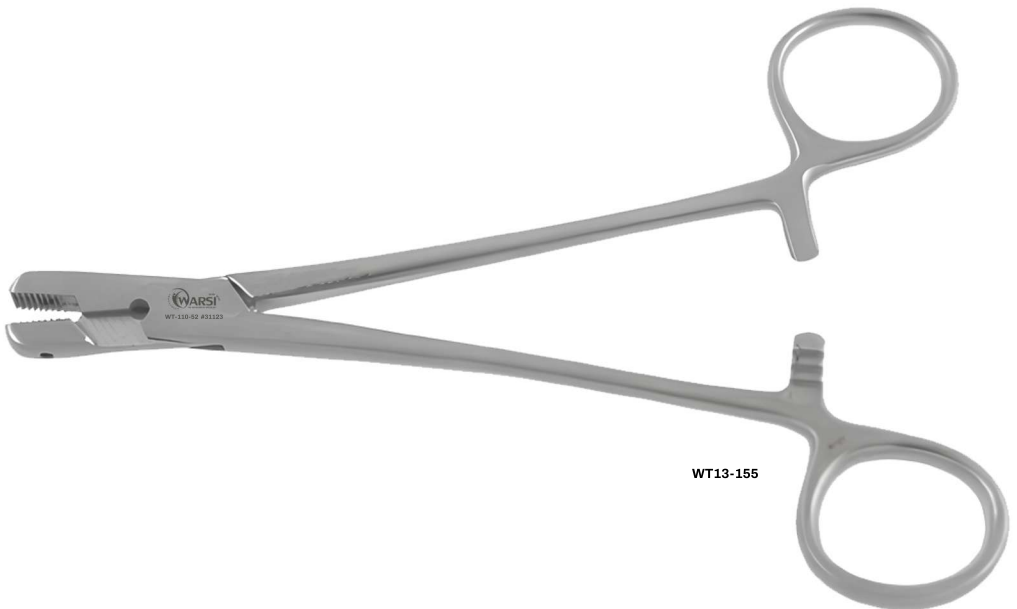

- **Wire Twister**
- **Needle holder style / with hole / 7" (18 cm)**  
**WT103-050**



- **Mini Jet Wire Twister Needle Holder**
- **Mayo needle holder style / TC serrated / 6 1/2" (16.5 cm)**  
**WT103-058M**

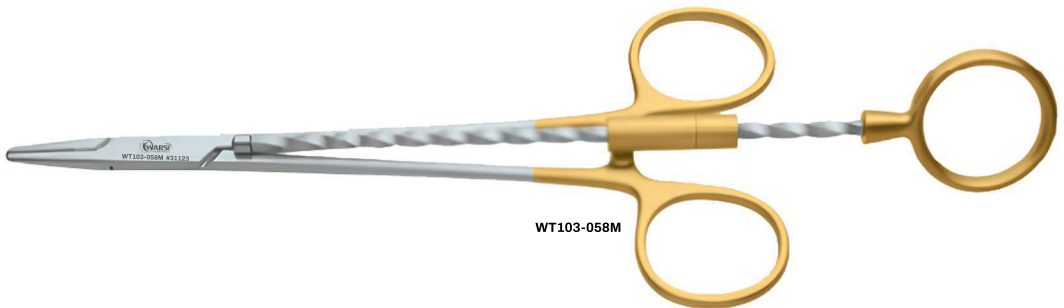

• **TC Jet Wire Twister Corkscrew Design Heavy Needle Holder**

- Broad jaw / 7" (17.8 cm)  
WT103-252A



• **Cerclage Torpedo Type Wire Twister**

- Stainless / 5" (12.5 cm)  
WT100-596



• **Bio-Met Wire Twister**

- Aluminum handle / 6" (15 cm)  
WT-03-158B



• **Bio-Met Type Wire Twister**

- 6" (15 cm)  
WT-103-71  
WT-103-72



• **Loute Wire Twister**

- Stainless / precise adjustment capabilities / 8 1/2" (22 cm)  
WT-100-96L



- **Bio-Met Wire Twister**
  - Aluminum handle / 6" (15 cm)
- WT-103-158B



- **Spring loaded with ratchet / 11" (28 cm)**
  - / without cutter
- WT-103-158S

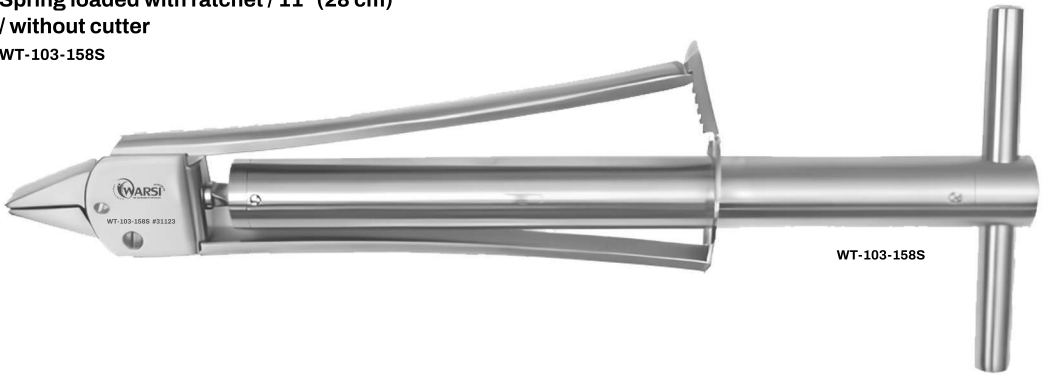

- **Cerclage Double Torpedo Type Wire Twister**
  - Stainless / phenolic handle / 9 3/4" (25 cm)
- WT-100-496D

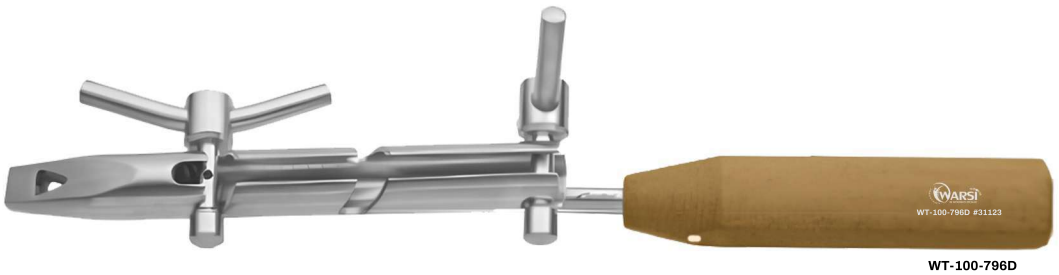



# ORTHOPEDIC RASPS



• **Double-Ended Rasp**

• **Single-sided / 7" (18 cm)**

WR03-224



WR03-224

• **wARSI® Fomon Rasp**

• **Double-ended / four-sided / 8 1/2" (21.5 cm)**

WR00-492 straight

WR00-492A straight fine

WR00-492B one end concave

WR00-492C one end convex

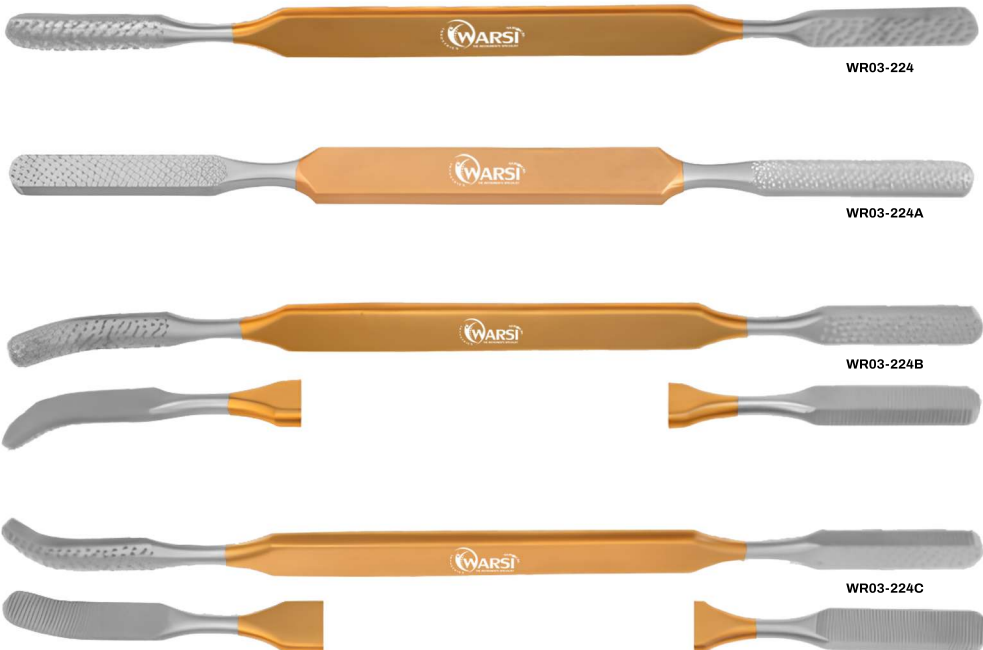

WR03-224

WR03-224A

WR03-224B

WR03-224C

• **Fomon Rasp**

• **Double ended / single-sided /**

**8 1/2" (21.5 cm)**

WR100-492F straight

WR100-492G one side concave

R100-492D one side convex



• **Foman TC Insert Rasp**

• **TC / double-ended / single-sided / 8 1/2" (21.5 cm)**

WR45-289 9 / 10

WR45-287 7 / 8

WR45-285 5 / 6

WR45-283 3 / 4

WR45-281 1 / 2

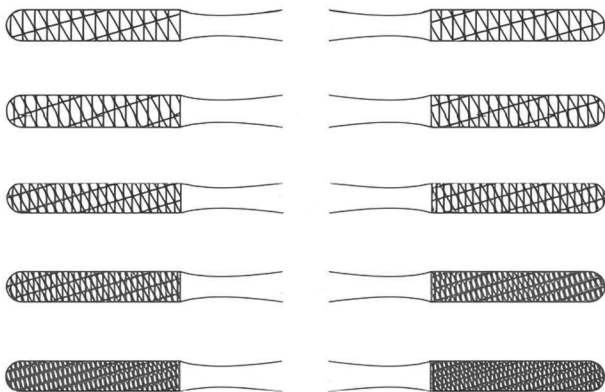

• **Foman Rasp**

- TC / double ended / single sided / angled

WR35-281A 1 / 2

WR35-283A 3 / 4

WR35-285A 5 / 6

WR35-287A 7 / 8

WR35-289A 9 / 10



• **Foman Rasp**

• **Serrated / double ended / single sided / 8" (20.3 cm)**

- WR45-290 1 / 2
- WR45-291 3 / 4
- WR45-292 5 / 6
- WR45-293 7 / 8
- WR45-294 9 / 10



WR45-290



WR45-291



WR45-292



WR45-293



WR45-294

• **Foman Rasp**

• **Foman Rasp TC serrated / double ended / 9" (22.9 cm)**

- WR45-2951 #1
- WR45-2952 #2
- WR45-2953 #3
- WR45-2954 #4
- WR45-2955 #5
- WR45-2956 #6
- WR45-2957 #7
- WR45-2958 #8
- WR45-2959 #9
- WR45-2950 #1



WR45-2957

• **Foman "R" Rasp**

- Double ended / TC / 8  
1/4" (21 cm)  
WR-45-279



WR-45-279

• **Polokoff Bone Rasp Double-Ended Single-Sided**

- WR03-241 5.5 mm / 6 mm 8"  
WR03-242 3 mm / 4 mm 7 1/2"



WR03-241



WR03-242

• **Howard Bone Rasp Double-Ended Single-Side**

- 7 1/8"  
WR03-223 #12  
WR03-225 #12A  
WR03-226 #12CA



WR03-223



WR03-225



WR03-226

• **Miller Bone Rasp Double-Ended Single-Sided Serrated**

• 7"

WR5-241 5 mm / 6 mm #33

WR5-242 3 mm / 4 mm #64

WR03-233 6 mm / 7 mm #10



• **Miller Bone Rasp Double-Ended Single-Sided**

• 7 1/2"

WR03-229 6 mm / 7 mm #45



• **Miller Rasp**

• Concave / single

ended / TC / 8" (20.25 cm)

WR45-305



• **Warsi - Miller TC Insert Rasp**

• Double-ended / TC / 7 1/8" (18.25 cm)

WR45-300 serrated

WR45-302 cross-serrated



- **Miller Cross Serrated Rasp**
- **Double-ended / cross-serrated / up & down rasping / 7 1/8" (18.25 cm)**

WR03-232 4 mm & 4 mm wide

WR00-490C 5 mm & 6 mm wide

WR03-225C 5 mm & 7 mm wide

WR00-491 6 mm & 7 mm wide



WR03-232

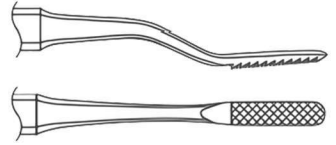
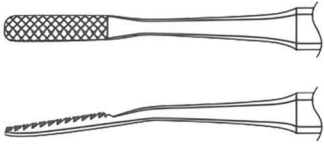

WR00-490C

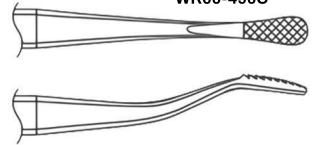
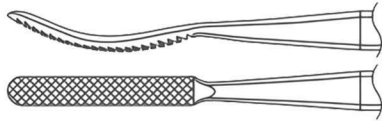

WR03-225C

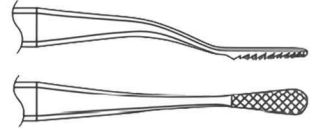
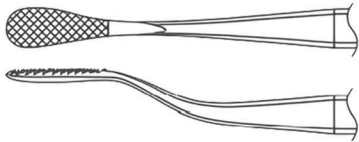

WR00-491

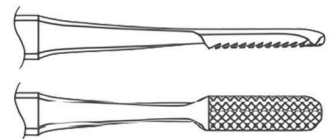
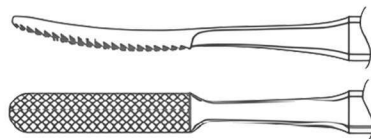

• **Miller Parallel Serrated Rasp**

• **Double-ended / regular cut / down rasping**

/ 7 1/8" (18.25 cm)

WR03-228 4 mm & 4 mm wide

WR00-490 5 mm & 5 mm wide

WR03-238 5 mm & 7 mm wide

WR03-236 5 mm & 8 mm wide

WR03-237 6 mm & 7 mm wide



WR03-228



WR00-490



WR03-238



WR03-236



WR03-237



• **Warsi Micro Rasp**

• **Single-ended / double-sided / 5 1/2" (14 cm)**

WR35-65 straight 2.1 mm x 30 mm x 1 mm

WR35-64 curved 3.2 mm x 30 mm x 2.5 mm

• **Single-ended / single-sided / special order**

WR35-66 5 1/2" (14 cm) 3 mm x 30 mm x 2.0 mm

WR35-67 7" (18 cm) 3 mm x 30 mm x 2.0 mm



WR35-65



WR35-64



WR35-67

• **Miller Bone Rasp Double-Ended Single-Sided**

• **7 1/2"**

WR03-229 6 mm / 7 mm #45



WR03-229

• **Miller Rasp**

• **Concave / single**

**ended / TC / 8" (20.25 cm)**

WR45-305

WR45-305G



WR45-305G



WR45-305

• **Rhinoplasty Rasp**

• **Straight / 7 3/4" (20 cm)**

WR45-312 teeth down

WR45-314 teeth up



• **Maltz Improved Double Ended Rasp**

• **Single-sided / up & down rasping / 8 1/4" (21 cm)**

WR103-235



• **McCullough Twist Fomon Raspatory**

• **Double-Ended-Single-Ended / TC / 8 1/2" (21.6 cm)**

WR45-350 #2/3

WR45-352 #4/6



• **Putti Bone Rasp**

• **WR45-220 leaflet / leaflet 10 1/2" (26.7 cm)**

WR45-218 conical / leaflet 12" (30.5 cm)



• **Putti Bone Rasp**

- Round blade / T-handle / 12" (30.5 cm)

WR45-24

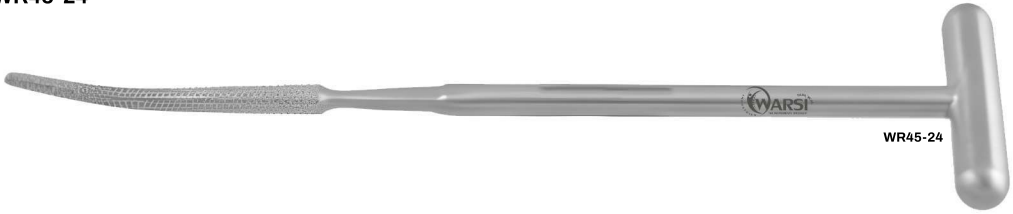

WR45-24

• **Putti Bone Rasp**

- Single-ended / phenolic handle

WR45-26 leaflet 9 3/4" (24.8 cm)

WR45-28 conical 10" (25.4 cm)



WR45-26



WR45-28

• **Single Side Rasp**

- 8" / phenolic handle / flat

WR45-22 straight 0.5" x 1.5" tip



WR45-22

- **Combination Bone Rasp**

- **With 3 interchangeable heads**

WR1100-485-SET

**set includes the following:**

WR110-85 combination bone rasp handle only

WR110-851 combination bone rasp round tip only

WR110-852 combination bone rasp putti leaflet only

WR110-853 combination bone rasp flat round tip only



WR110-85



WR110-851

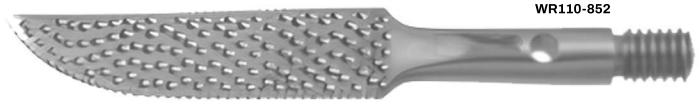

WR110-852



WR110-853

• **Gallaher Bone Rasp Set**

- 7 1/8" (18.25 cm)  
WR77-450 str  
WR77-451 convex curve  
WR77-452 concave curve

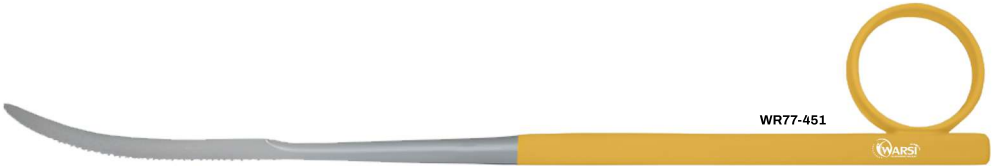
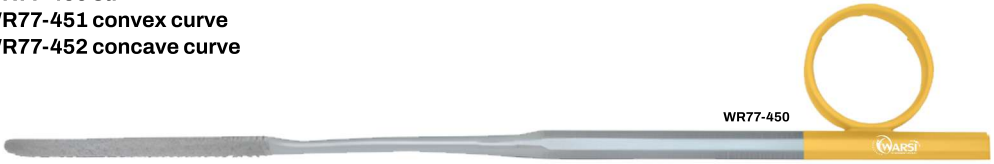

• **Good Bone Rasp**

- Conical / 6 1/2" (16.5 cm)  
WR45-63 straight  
WR45-62 curved



• **Warsi Ear Rasp Set**

• **Serrated / 6" (15.2 cm)**

WR75-96 curved left

WR75-98 curved right

• **7 1/4" (18.5 cm)**

WR75-10 curved right

WR75-05 curved right serrated

WR75-00 curved left serrated

WR75-15 set of all three



WR75-96



WR75-98



WR75-10



WR75-05



WR75-00

• **Kistler Ear Cartilage Rasp**

• Curved / 6 1/2" (16.5 cm)

WR75-18L left

WR75-18R right



WR75-18L



WR75-18R

• **Glabella Masing Rasp**

• TC / 7 3/4" (19.5 cm)

WR45-40



WR45-40

• **Warsi Glabella Pull Push Curved Tip Rasp**

• Single-ended / curved / 7 1/2" (19 cm)

WR45-42 teeth cut down pull

WR45-44 teeth cut up push



WR45-42



WR45-44

• **Warsi Patella Raspatory**

• #4 / TC insert / 7 1/8" (18 cm)

WR-45-247



WR-45-247

• **Masing Rasp**

• Single ended / straight  
/ TC / 7 3/4" (19.5 cm)

WR-45-289R course

WR-45-338 fine



WR-45-289R



WR-45-289

• **Warsi Diamond Surface Rasp**

• 7 3/8" (18 cm)

WR-45-345 straight

WR-45-346 curved



WR-45-245



WR-45-246

• **-Glabella Sculpting TC Insert Rasp**

• TC / 7" (18 cm)

WR-45-246



WR-45-246

• **Webster Glabella Sculpting Rasp**

• TC serrated tip / 4 mm x 8 mm / 8 1/4" (21 cm)

WR-45-246A



WR-45-246A

• **Obwegeser Fenestrated Serrations Rasp**

• Double-ended / flat, straight / infinity cut / 7 1/2" (19 cm)

WR45-320 fine grit

WR45-322 medium grit



WR45-322

Double-ended / flat, curved / infinity cut / 7 1/2" (19 cm)

WR45-324 fine grit

WR45-326 medium grit



WR45-326

Double-ended / concave / infinity cut / 7 1/2" (19 cm)

WR45-330 fine grit

WR45-332 medium grit



WR45-330

- **Warsi Spinal File/Rasp**
- **Phenolic handle / TC / 10" (25.4 cm)**  
/ curved  
WR-45-270



WR-45-270

- **Phenolic handle / cross-serrated / straight / 6.5 mm / 15" (38 cm)**  
WR-45-216



WR-45-216

- **Black plastic handle / 6 mm**  
WR-45-216B straight 15" (38.1 cm)  
WR-45-215B angled 14 1/2" (36.8 cm)



WR-45-216B



WR-45-215B

• **Long Handle File**

- **Black plastic handle / square file / 18" (45.7 cm)**

WR120-91 straight

WR120-92 15° angle

- **Black plastic handle / round file / straight / 18" (45.7 cm)**

WR120-93



WR120-91



WR120-92



WR120-93

• **JPS Bone File**

- **8 3/4" (22.2 cm)**

WR45-217



WR45-217



# ORTHO ABDOMINAL RETRACTOR

- **CSU Pediatric Balfour Retractor**
- **Fenestrated side blades / double bar**  
100-16-WR -SET 4" (10 cm) spread  
100-16B-WR -SET 7" (18 cm) spread
- \*Modifications possible please call for details

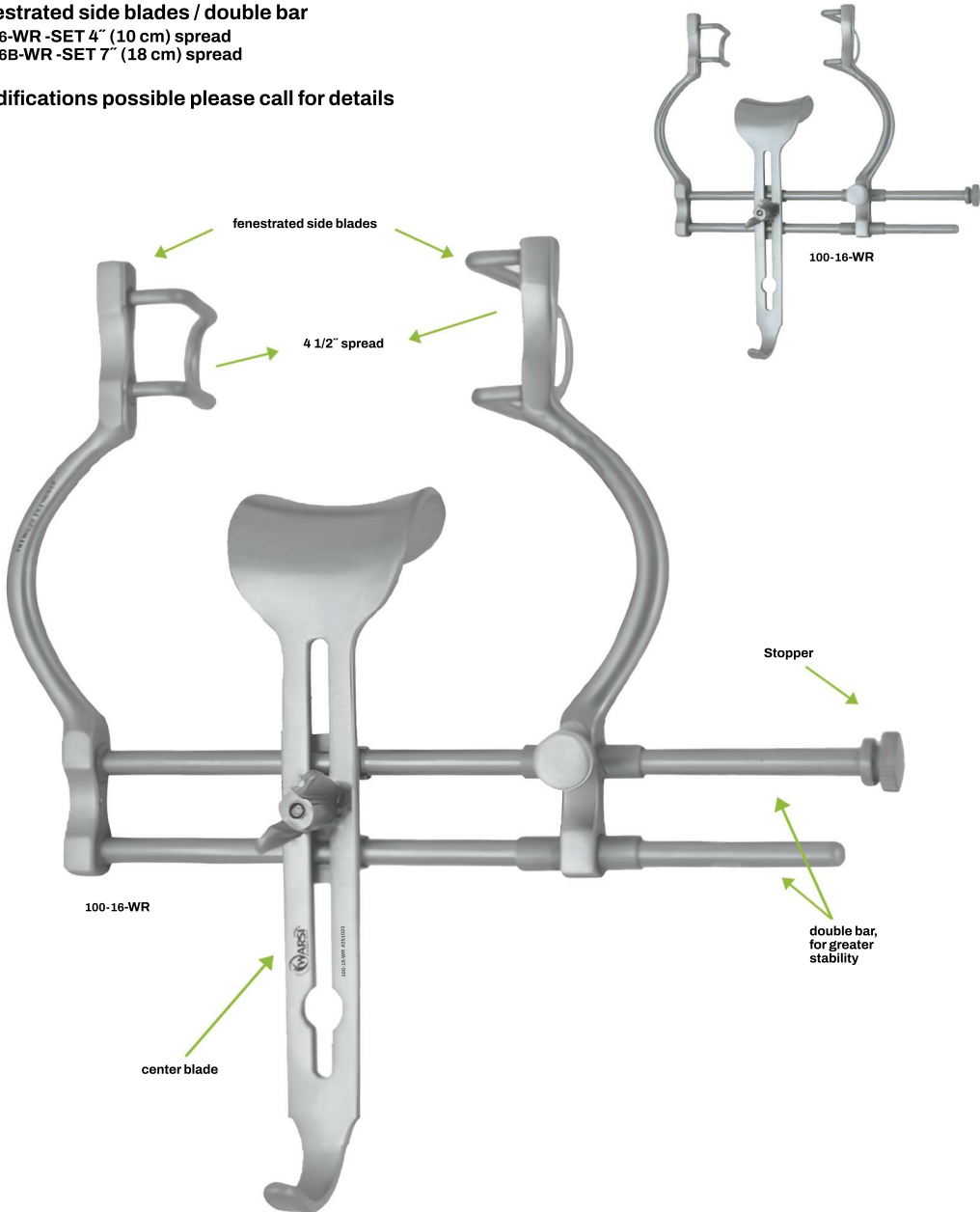

- **CSU Pediatric Balfour Retractor**
- Fenestrated side blades, 4.5 cm x 4.5 cm / double bar  
WR-100-1-SET 7" (18 cm) spread
- \*Modifications possible please call for details

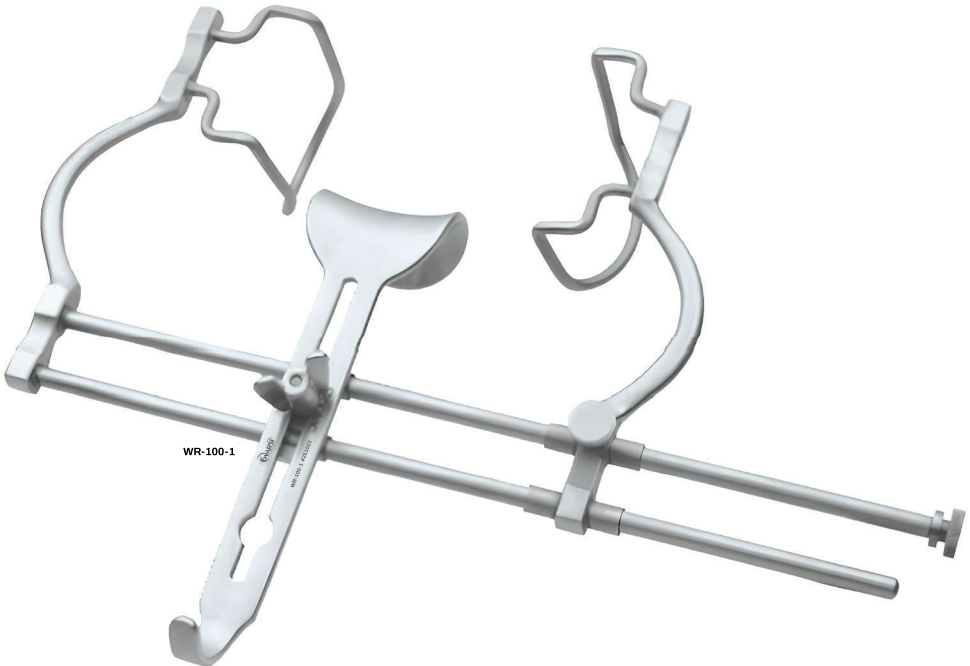

• **CSU Pediatric Balfour Retractor**

- Fenestrated side blades, 4.5 cm x 4.5 cm / double bar  
Single bar / fenestrated / side blades

- Modifications possible please, different center blades available, call for details

Dimensional Diagram

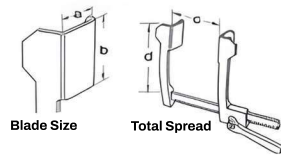

*	a	a	a	a
	2 in 50 mm	1 in 25 cm	7.5 in 190 mm	5.5 in 140 mm



WR-100-2

Single Bar

Stopper

center blade

fenestrated side blades

WR-100-2

- **CSU Pediatric Balfour Retractor**

- **Double bar / fenestrated / side blades**

WR-100-3-SET 7" (18 cm) spread  
 WR-100-4-SET 9" (23 cm) spread  
 WR-100-5-SET 10 1/2" (26 cm) spread

- **Modifications possible please, different center blades available, call for details**

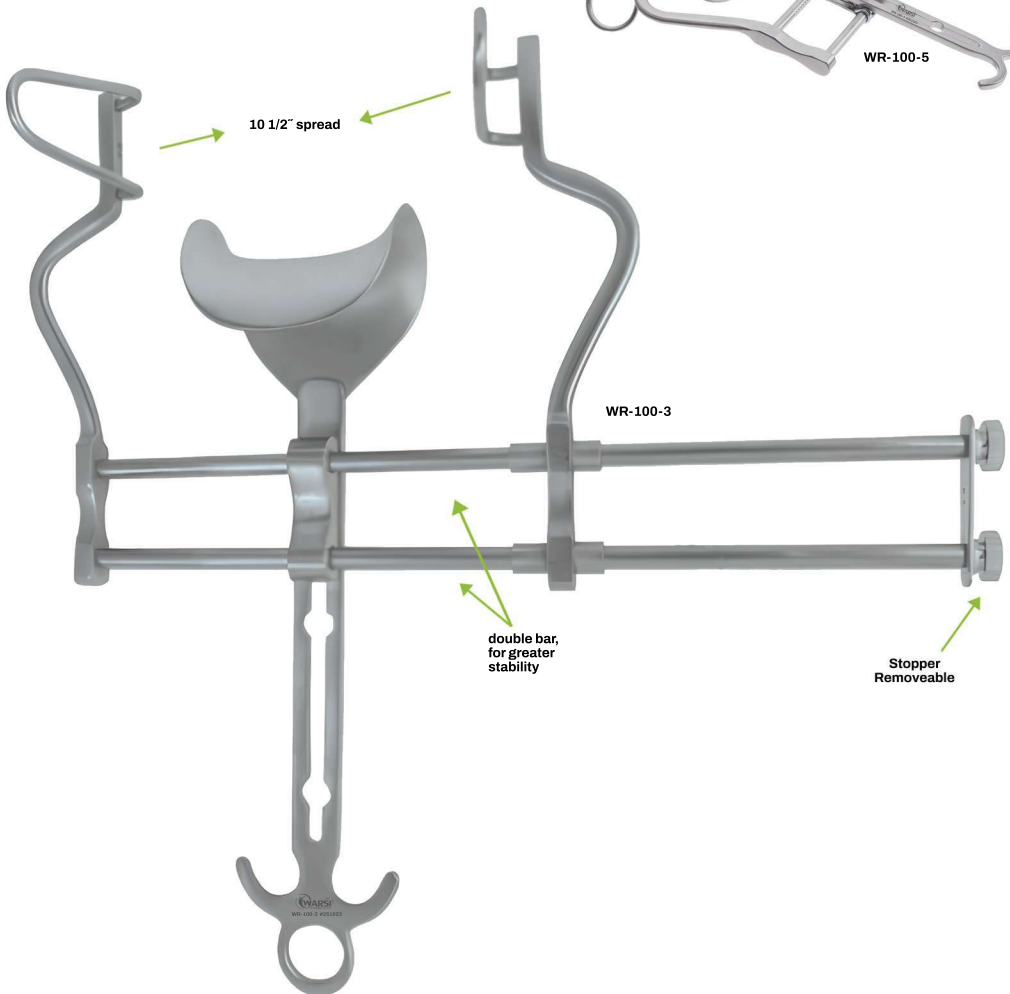

- **Deluxe Balfour Retractor**
- **Double bar / interchangeable, fenestrated / side blades / ratchet locking frame**

WR-100-6-SET 8 1/2" (22 cm) spread  
 WR-100-7-SET 10 1/2" (26 cm) spread  
 WR-100-8-SET 14" (36 cm) spread

- **Available Side Blades**

WR-100-9 2 1/2" long  
 WR-100-10 3 1/2" long

\* Different center blades available, call for details

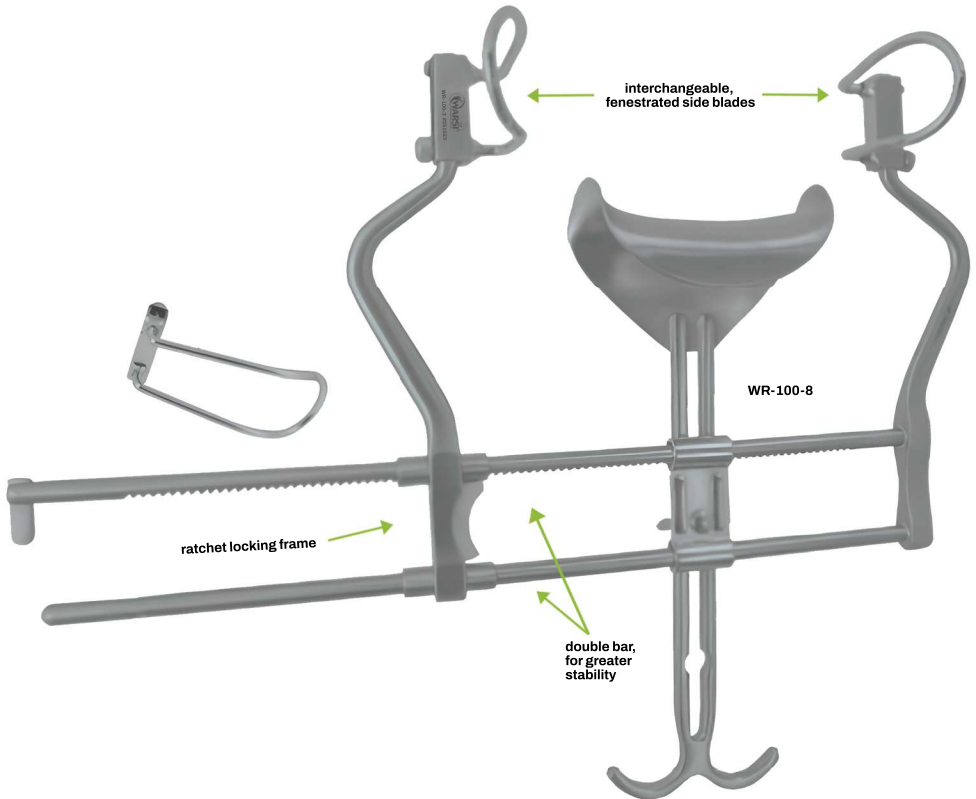

• **CSU Pediatric Balfour Retractor**

- Fenestrated side blades / single bar

WR-100-11-SET 4" (10 cm) spread  
WR-100-11B-SET 7" (18 cm) spread

- \*Modifications possible please call for details

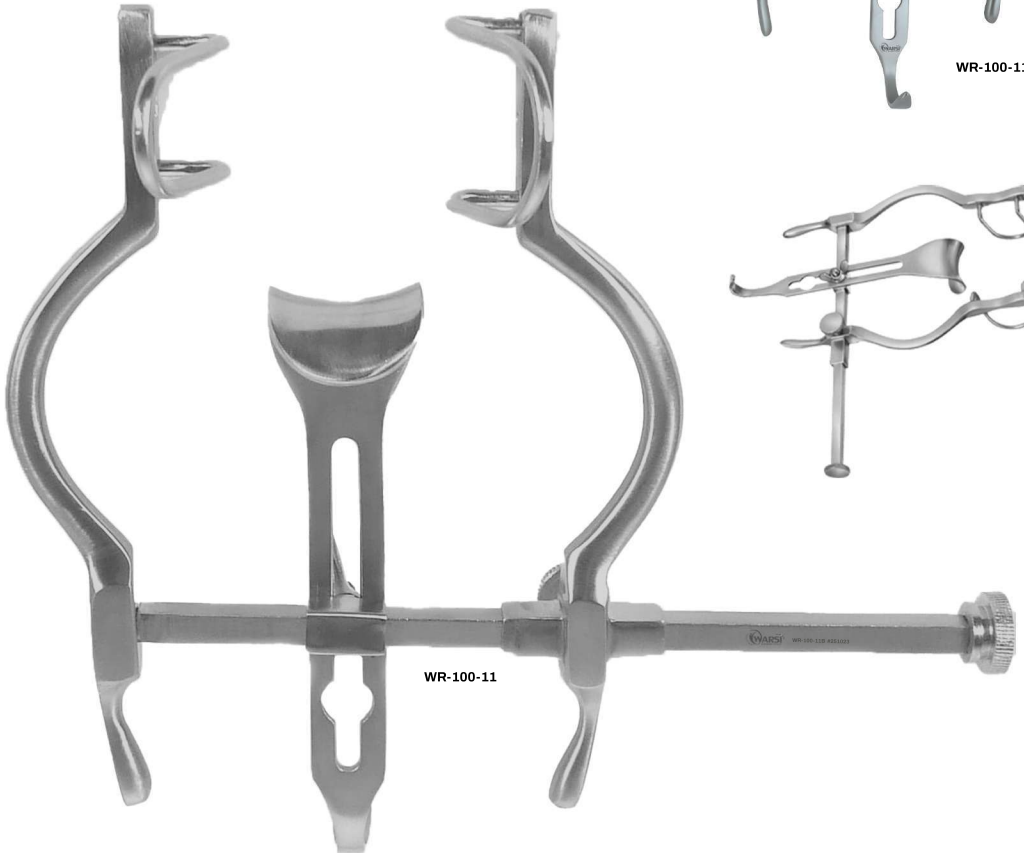

- **Deluxe Balfour Retractor**
- **Extended 20" rack for obese patients / includes 2 blades**

WR-100-12

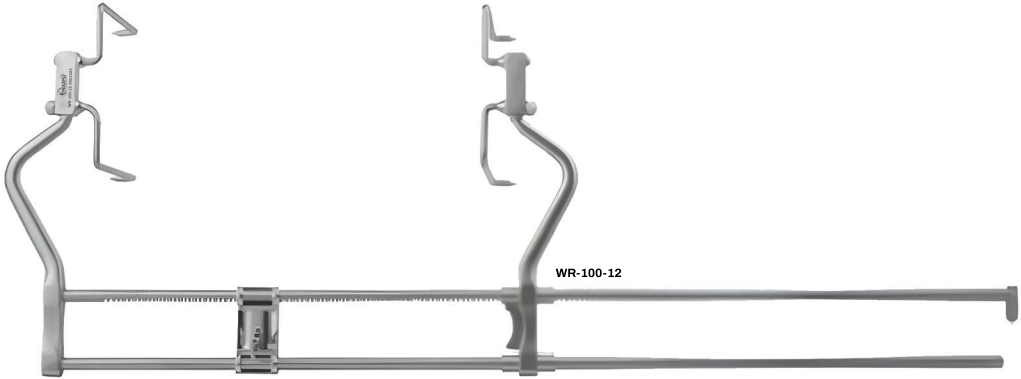

- **Olaitan Spiked Obese Blades**
- **Set of 2 / 4" wide prong to prong / right angled at spike**

WR-100-13



• **Balfour Malleable Blade Retractor**

- With protected edge / fits all Balfour Retractors

100-13-WR 1 1/2" x 6"

100-14-WR 2" x 6"

100-15-WR / Sharpe edges

\* Different center blades available, call for details





**ORTHO METZENBAUM SCISSORS**

**Warsi® Scissors are simply unmatched in design, function, quality and variety. Sontec Scissors are offered in any model blade, shape or size in all of our model options listed below:**

• **Classic Model**

BH-113-41

- Combining extremely high quality with unmatched value
- Satin or high gloss finish

• **Tungsten Carbide - TC inserts**

Gold Rings

- diamond-ground tungsten-carbide inserts
- extremely sharp
- Blade hardness greatly increases scissor life
- available with or without serrations

• **Powercut blades® - PC gold**

Gold Rings with Stripes on Shanks

- sharpest cutting edge available
- serrated unless otherwise requested
- Finished in Sontec's Trademarked PC Gold design
- All the attributes of Sontec PC Black scissors

• **Powercut blades® - PC black**

Black Rings

- All the attributes of Sontec PC Gold
- Beautifully ornamented in black chrome

• **Tungsten Carbide / Power Cut - TC/PC:**

Gold Ring / Black Ring

- Serrated unless otherwise requested
- a combination of the best options
- HANDLE: one gold ring, one black ring
- This premier line encompasses TC long life, PC power, and Sontec Quality

• **Ceramic Coated Scissors:**

Black Ring

- offered to protect your investment even further by putting the instrument into an extremely hard coating which adds more life to your Sontec Scissors
- Offered in either PC or TC/PC models



• **Metzenbaum Brophy Sharp/Sharp Tip Scissors**

- **Sharp/sharp tips / power cut / 5 3/4" (14.5 cm)**  
MM75-58 straight  
MM75-60 curved



- **Sharp/sharp tips / tungsten carbide / delicate / 5 3/4" (14.5 cm)**  
MM00-35S straight  
MM00-37C curved

- **Sharp/ tungsten carbide / power cut / 5 3/4" (14.5 cm)**  
MM400-36 straight  
MM400-38 curved

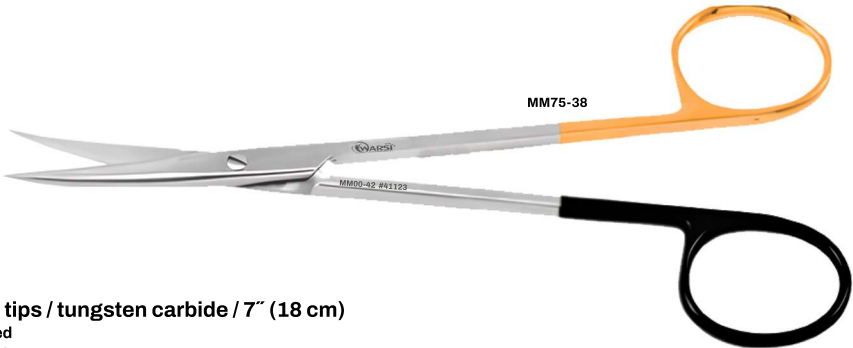

- **Sharp/sharp tips / tungsten carbide / 7" (18 cm)**  
MM12-506 curved  
MM12-418 straight

- **Sharp/sharp tips / tungsten carbide / delicate / 7" (18 cm)**  
MM40-39 straight  
MM40-40 curved



• **Metzenbaum Ceramitec Power Cut® Scissors**

- **Special / ceramic coated scissors / with Power Cut blades / black with gold screw / curved / spread handle / 4 1/2" (11.4 cm)**

MM00-899

\* Titanium Nitrate Coating is a very hard coating that keeps scissors sharper longer, reduces friction and adds a layer of corrosion protection



MM00-899

• **Stussak Metzenbaum Power Cut® Gold Scissors**

- **Strong curve / blunt / 7" (17.8 cm)**

MM100-35 classic

MM08-17 PC



MM100-35

• **Metzenbaum Ceramitec Power Cut® Scissors**

• **Special / ceramic coated scissors / with Power Cut blades / black with gold screw / curved**

1200-911 5 3/4" (15 cm)

1200-912 5 3/4" (15 cm)

1200-915 7" (18 cm)

1200-916 delicate 7" (18 cm)



\* Titanium Nitrate Coating is a very hard coating that keeps scissors sharper longer, reduces friction and adds a layer of corrosion protection



• **Metzenbaum Ceramitec TC/PC Scissors**

- **Special / ceramic coated scissors / with TC/PC curved blades / black with gold screw and gold shiny rings**

MM00-13 5 3/4"

MM00-19 7"

- **Special / ceramic coated scissors / with TC/PC curved blades / black with gold screw and gold shiny rings / spread handle**

MM00-14 5 3/4"

MM00-192 7"



MM00-14



MM00-192

• **Metzenbaum Power Cut® Black Scissors**

• **Power Cut Black (PC Black) / 7" (18 cm)**

WMO-0-788 straight

WMO-0-790 curved

WMO-0-797 curved 2.5mm tip



WMO-0-788

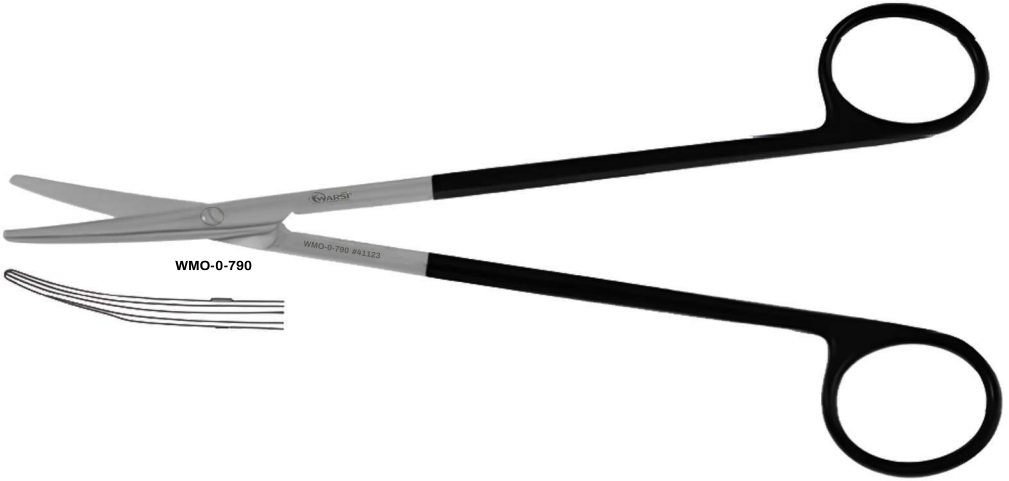

WMO-0-790

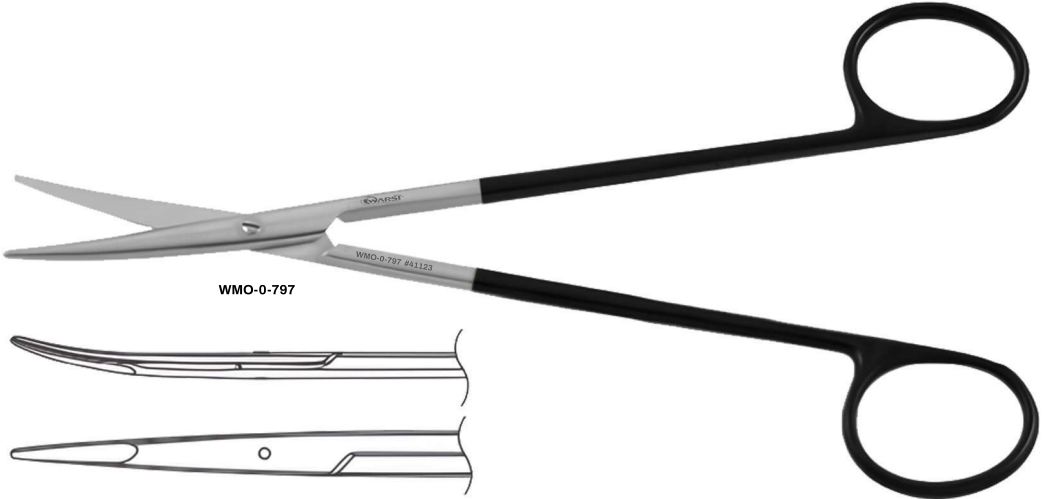
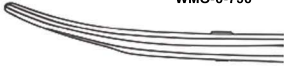

WMO-0-797

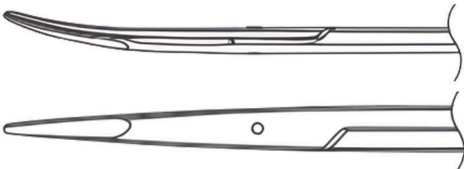

• **Metzenbaum Power Cut® Black Scissors**

• **Power Cut Black (PC Black) / 8" (20.5 cm)**

- SO00-798 straight
- SO00-800 curved
- SO00-801 curved tenotomy tip
- SO00-820 straight delicate
- SO00-819 curved delicate

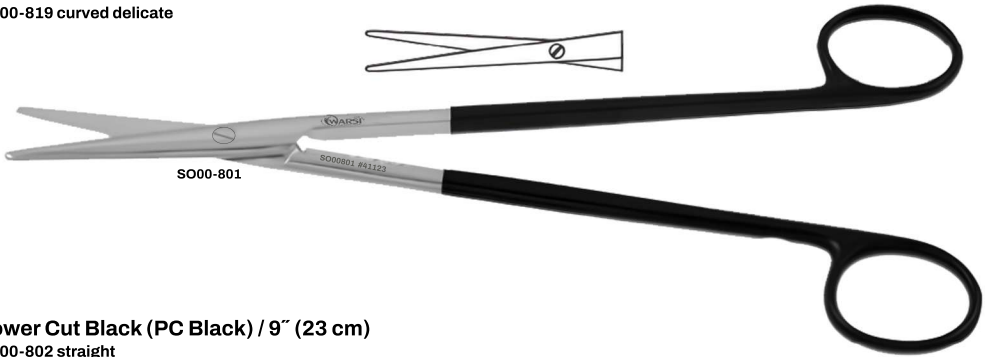
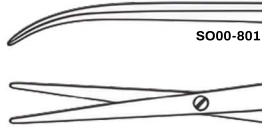

• **Power Cut Black (PC Black) / 9" (23 cm)**

- SO00-802 straight
- SO00-804 curved
- SO00-822 straight delicate
- SO00-821 curved delicate



• **Power Cut Black (PC Black) / 10 1/4" (26 cm)**

- SO00-806 straight
- SO00-808 curved
- SO00-807 straight delicate
- SO00-809 curved delicate

**Power Cut Black (PC Black) / 11" (28 cm)**

- SO00-803 straight
- SO00-805 curved

**Power Cut Black (PC Black) / curved / 12" (30.5 cm)**

SO00-811



• **Metzenbaum Power Cut® Black Scissors**

• **PC Black / 4 3/4" (12.1 cm)**

SO00-785 straight  
SO00-787 curved



• **Metzenbaum Ceramic Coated Power Cut® Scissors**

• **Special / ceramic coated scissors / with Power Cut blades / delicate / 5" (13 cm)**

SO00-900 straight  
SO00-905 curved

**Special / ceramic coated scissors / with Power Cut blades / 5 3/4" (15 cm)**

SO00-909 straight  
SO00-908 curved

**Special / ceramic coated scissors / with TC/PC blades / curved / delicate**

SO00-910 5 3/4" (15 cm)  
SO00-904 7" (18 cm)

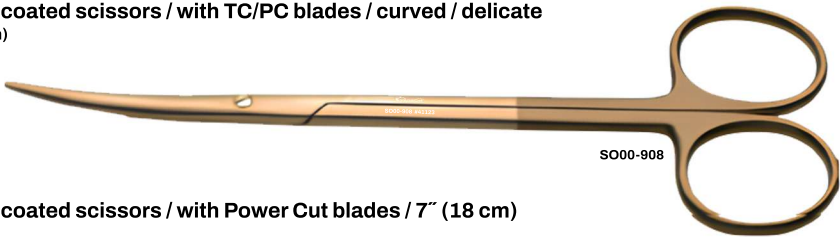

• **Special / ceramic coated scissors / with Power Cut blades / 7" (18 cm)**

SO00-907 straight  
SO00-906 curved  
SO00-902 straight delicate



\* Titanium Nitrate Coating is a very hard coating that keeps scissors sharper longer, reduces friction and adds a layer of corrosion protection

• **Metzenbaum Power Cut® Black Scissors**

• **Power Cut Black (PC Black) / 7" (18 cm)**

- SX40-817 curved delicate
- SX40-818 straight delicate
- SX40-818M straight extra delicate
- SX40-817M curved extra delicate
- SX40-817F full curved extra delicate



• **Metzenbaum-Toennis Power Cut® Black Scissors**

• **PC black / extra delicate / 7" (18 cm)**

- SX40-841 curved



• **Metzenbaum Power Cut® Black Scissors**

- **Power Cut Black (PC Black) / fine tip / curved / 5 3/4" (14.6 cm)**  
SX40-815



• **Metzenbaum Power Cut® Black Scissors**

- **Power Cut Black (PC Black) / 6" (15 cm)**  
SX40-790 straight unique short blades  
SX40-792 curved unique short blades  
SX40-816 straight delicate  
SX20-770 curved tenotomy tip ergonomic spread handle

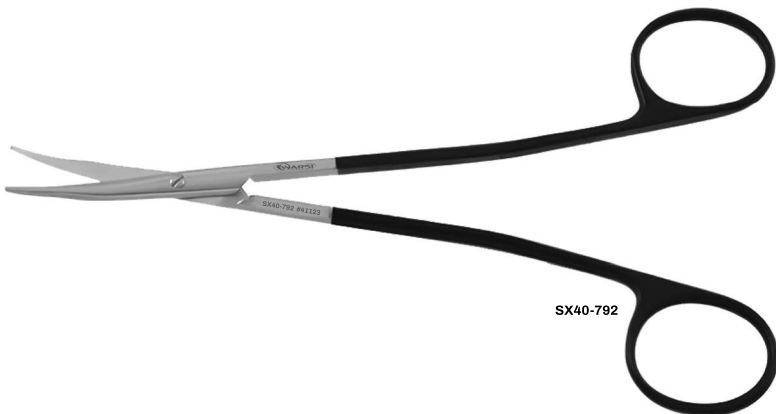
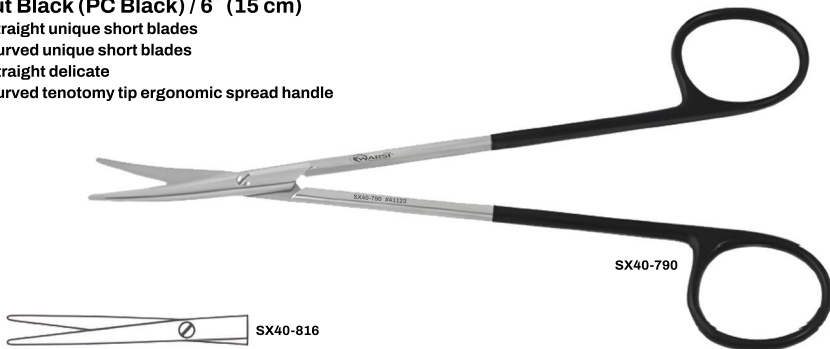

• **Metzenbaum Power Cut® Gold Long Model Scissors**

• **Power Cut Gold (PC Gold) / 9" (23 cm)**

- SX40-302 straight
- SX40-304 curved
- SX40-322 straight delicate
- SX40-321 curved delicate

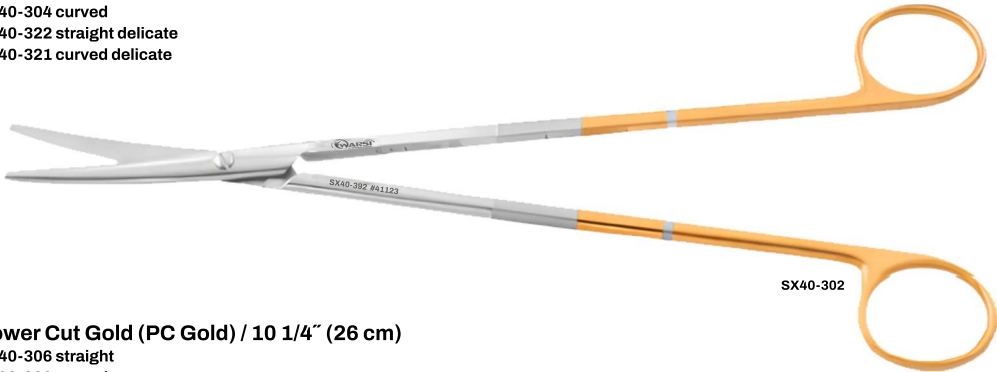

SX40-302

• **Power Cut Gold (PC Gold) / 10 1/4" (26 cm)**

- SX40-306 straight
- SX40-308 curved
- SX40-309 straight delicate
- SX40-323 curved delicate



SX40-306

• **Power Cut Gold (PC Gold) / curved /**

- SX40-310 11" (28 cm)
- SX40-311 12" (30.5 cm)
- SX20-268 14" (35.5 cm)
- SX20-269 16" (40.5 cm)
- SX20-270 18" (45.5 cm)



SX40-311

• **Metzenbaum Power Cut® Black Scissors**

• **Power Cut Black (PC Black) / 4 1/2" (11.5 cm)**

- SX00-775M straight baby
- SX12-776M curved baby

**Power Cut Black (PC Black) / 5" (13 cm)**

- SX12-780 straight
- SX12-782 curved
- SX12-750 straight tenotomy tip
- SX12-752 curved tenotomy tip

**Power Cut Black (PC Black) / extra delicate / 5 1/4" (13.5 cm)**

- SX24-812A straight
- SX24-813A curved

**Power Cut Black (PC Black) / extra delicate / 5 5/8" (14 cm)**

- SX40-814A straight
- SX24-815A curved

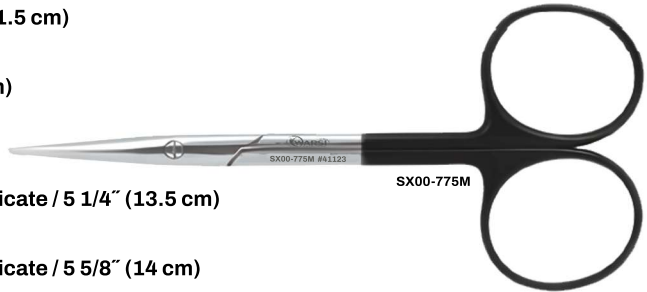

• **Power Cut Black (PC Black) / tenotomy tip / 5 3/4" (14.5 cm)**

- SX12-760 straight
- SX12-762 curved



• **Power Cut Black (PC Black) / 5 3/4" (14.5 cm)**

- SX12-784 straight
- SX12-786 curved
- SX12-783 straight delicate
- SX12-787 curved delicate

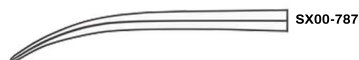

• **Metzenbaum Power Cut® Gold Scissors**

• **Power Cut Gold (PC Gold) / curved / 7" (18 cm)**

- WJ00-342
- WJ00-342H heavy
- WJ00-342L left handed
- WJ00-344 ergonomic spread handle
- WJ00-317 delicate
- WJ00-330 2.5 mm tip

**Power Cut Gold (PC Gold) / 8" (20.5 cm)**

- WJ00-360 straight
- WJ00-362 curved
- WJ00-318 straight delicate
- WJ00-319 curved delicate



WJ00-342H



WJ00-360

• **Metzenbaum Power Cut® Gold Scissors**

• **Power Cut Gold (PC Gold) / 4 3/4" (12 cm)**

SO00-326 straight

SO00-328 curved

**Power Cut Gold (PC Gold) / 5" (12.5 cm)**

SO00-286 straight

SO00-287 curved

**Power Cut Gold (PC Gold) / straight / 5 3/4" (15 cm)**

SO00-330

SO00-334 delicate

**Power Cut Gold (PC Gold) / curved / 5 3/4" (15 cm)**

SO00-332

SO00-335 delicate

SO00-347 ergonomic spread handle



SO00-328

• **Power Cut Gold (PC Gold) / 6" (15 cm) / delicate / short blade**

SO00-314 straight

SO00-315 curved

SO00-330L straight left



SO00-314

• **Power Cut Gold (PC Gold) / straight / 7" (18 cm)**

SO00-340

SO00-316 delicate

• **Metzenbaum Tungsten Carbide Long Model Scissors**

• **Tungsten Carbide (TC) / 9" (23 cm)**

- SO00-273 straight
- SO24-275 curved
- SO00-260 straight delicate
- SO24-262 curved delicate

• **Tungsten Carbide (TC) / 10" (25.5 cm)**

- SO24-279 straight
- SO24-280 curved



• **Tungsten Carbide (TC) / 11" (28 cm)**

- SO00-277 straight
- SO00-278 curved
- SO24-264 curved delicate

• **Tungsten Carbide (TC) / 12" (30.5 cm)**

- SO00-341 straight
- SO00-345 curved

• **Tungsten Carbide (TC) / curved / extra long**

- SO10-847 14" (35.5 cm)
- SO10-849 16" (40.5 cm)
- SO10-850 18" (45.5 cm)



• **Metzenbaum Tungsten Carbide Power Cut® Gold/Black Scissors**

• **Strabismus / tungsten Carbide /Power Cut (TC/PC) / 4 1/2" (11.5 cm)**

SO12-50 straight  
SO12-51 curved

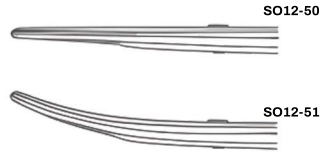

• **Tungsten Carbide /Power Cut (TC/PC) / Serrated / 5 3/4" (14.5 cm)**

SO12-505 straight  
SO12-510 curved  
SO12-507 straight delicate  
SO12-512 curved delicate  
SO12-514 curved ergonomic spread handle

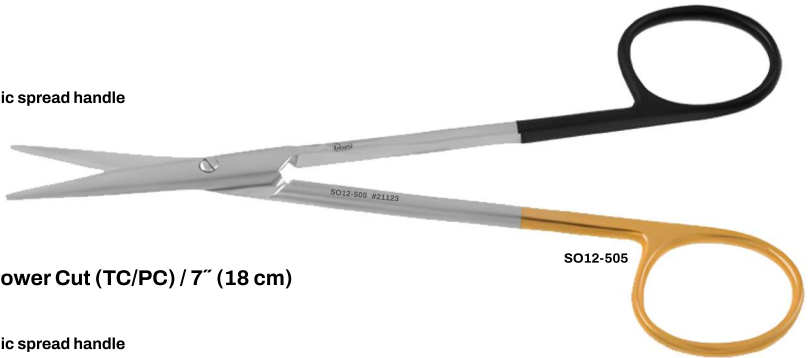

• **Tungsten Carbide /Power Cut (TC/PC) / 7" (18 cm)**

SO12-515 straight  
SO12-520 curved  
SO12-526 curved ergonomic spread handle  
SO12-526S curved ergonomic spread handle sharp tips  
SO24-247 curved delicate

• **Tungsten Carbide /Power Cut (TC/PC) / 8" (20.5 cm)**

SO12-530 straight  
SO12-529 curved  
SO12-531 curved ergonomic spread handle  
SO24-248 curved delicate



• **Tungsten Carbide /Power Cut (TC/PC) / 9" (23 cm)**

SO12-535 straight  
SO12-536 curved  
SO24-259 curved delicate

• **Tungsten Carbide /Power Cut (TC/PC) / 10" (25.5 cm)**

SO12-537 straight  
SO12-538 curved  
SO24-281 curved delicate

• **Metzenbaum Tungsten Carbide Scissors**

• **Tungsten Carbide (TC) / 5 3/4" (15 cm)**

- SO00-265 straight
- SO00-267 curved
- SO00-250 straight delicate
- SO00-252 curved delicate

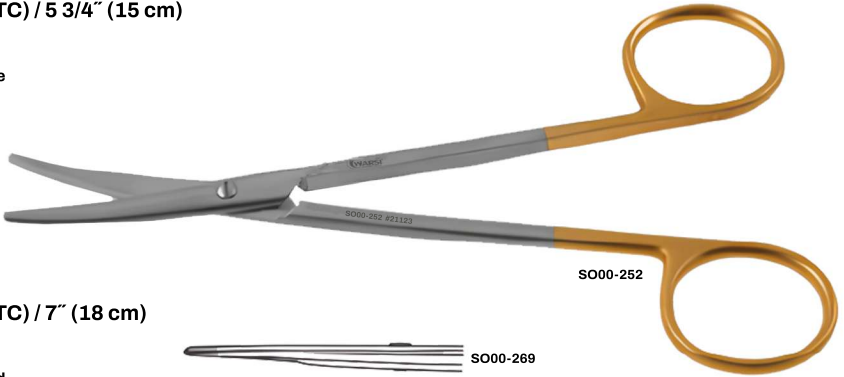

• **Tungsten Carbide (TC) / 7" (18 cm)**

- SO00-269 straight
- SO00-270 curved
- SO00-253 curved s-curved
- SO00-254 straight delicate
- SO00-256 curved delicate

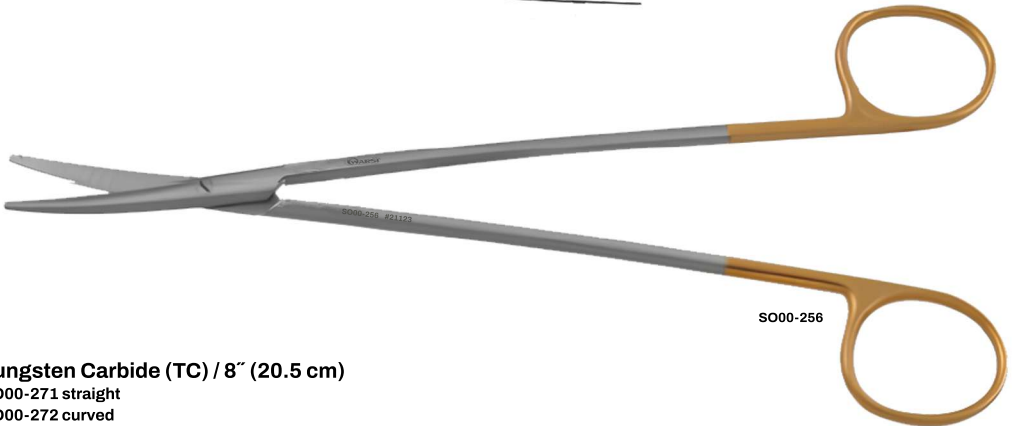

• **Tungsten Carbide (TC) / 8" (20.5 cm)**

- SO00-271 straight
- SO00-272 curved
- SO00-255 curved s-curved
- SO00-257 straight delicate



• **Metzenbaum Classic Model Scissors**

• **Classic model / 8" (20.5 cm)**

- ME-1100-20 straight
- ME-110-24 curved
- ME-240-32 straight fino



• **Classic model / 9" (23 cm)**

- ME-110-30 straight
  - ME-110-30 curved
  - ME-240-35 curved extra-light
- Classic model / 10" (25.4 cm)**  
straight
- ME-110-25 curved



• **Metzenbaum Scissors**

• **Curved / power cut silver / 5 3/4" (14.6 cm)**

- ME-120-33
- ME-120-33G



• **Metzenbaum S-Curved Power Cut® Gold Scissors**

- **Power Cut Gold (PC Gold) / s-curved / curved shank & blade**  
ZX10-525 7" (17.8 cm)  
ZX10-523 8" (20.5 cm)

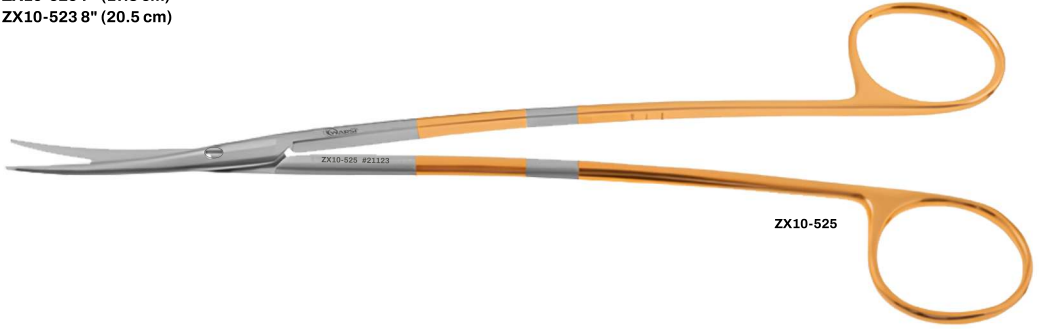

ZX10-525



ZX10-523

• **Metzenbaum Bayonet Power Cut® Gold Scissors**

- **Power Cut Gold (PC Gold) / bayonet / curved / 7" (18 cm)**  
ZX10-370  
ZX10-372 tenotomy tips

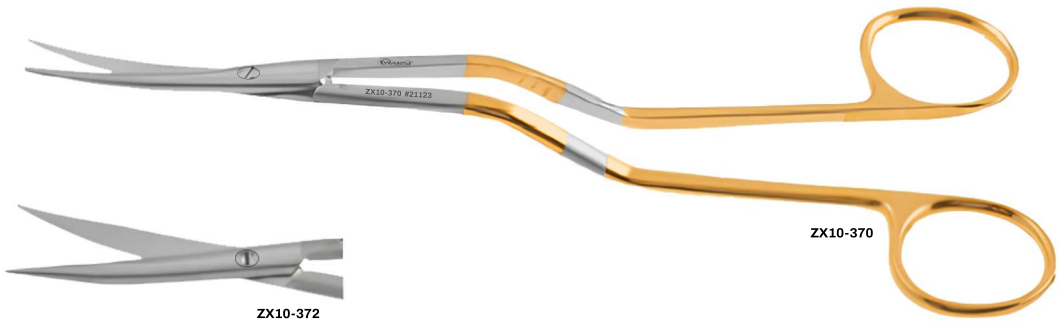

ZX10-370



ZX10-372

• **Metzenbaum Classic Model Scissors**

• **Classic model / 4 1/2" (11.5 cm)**

SOO-233 straight

SOO-241 curved

**Classic model / 5 3/4" (14.5 cm)**

SOO-236 straight

SOO-236L straight left handed

SOO-242 curved

SOO-346 curved extra-light

SOO-347 curved extra-light tenotomy tip



• **Classic model / 6" (15 cm)**

SOO-291 curved delicate

**Classic model / 7" (18 cm)**

SOO-238 straight

SOO-244 curved

SOO-349 curved extra-light





# BANDAGE & SUTURE SCISSORS

**Warsi® Scissors are simply unmatched in design, function, quality and variety. Sontec Scissors are offered in any model blade, shape or size in all of our model options listed below:**

• **Classic Model**

BH-113-41

- Combining extremely high quality with unmatched value
- Satin or high gloss finish

• **Tungsten Carbide - TC inserts**

Gold Rings

- diamond-ground tungsten-carbide inserts
- extremely sharp
- Blade hardness greatly increases scissor life
- available with or without serrations

• **Powercut blades® - PC gold**

Gold Rings with Stripes on Shanks

- sharpest cutting edge available
- serrated unless otherwise requested
- Finished in Sontec's Trademarked PC Gold design
- All the attributes of Sontec PC Black scissors

• **Powercut blades® - PC black**

Black Rings

- All the attributes of Sontec PC Gold
- Beautifully ornamented in black chrome

• **Tungsten Carbide / Power Cut - TC/PC:**

Gold Ring / Black Ring

- Serrated unless otherwise requested
- a combination of the best options
- HANDLE: one gold ring, one black ring
- This premier line encompasses TC long life, PC power, and Sontec Quality

• **Ceramic Coated Scissors:**

Black Ring

- offered to protect your investment even further by putting the instrument into an extremely hard coating which adds more life to your Sontec Scissors
- Offered in either PC or TC/PC models



• **Bruns Plaster Shears**

- One serrated blade / 9 1/2" (24 cm)  
 WS-413-15



• **Esmarch Heavy Bandage Scissors**

- 8" (20.5 cm)  
 WS-413-16 classic  
 WS-413-17 PC

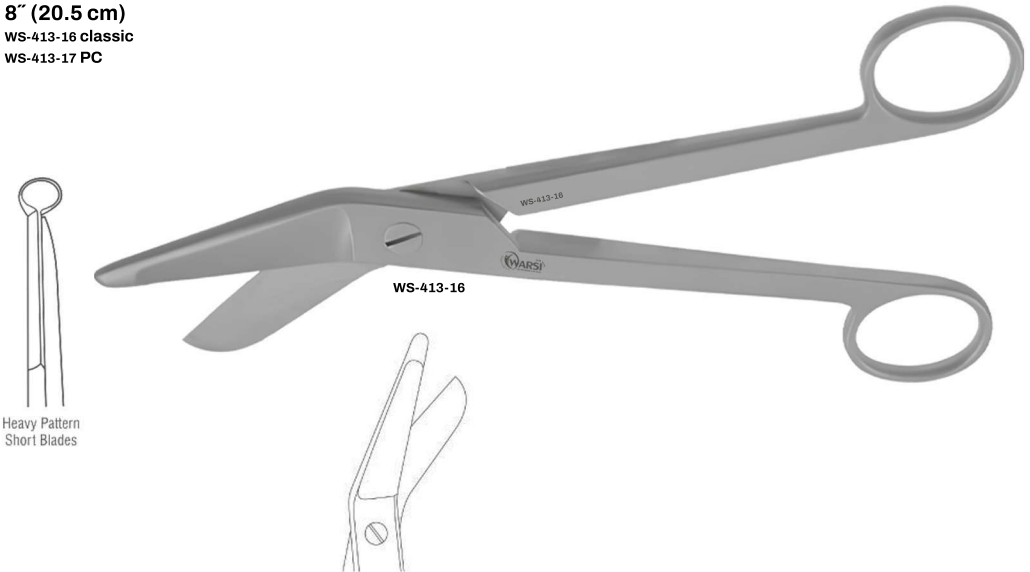

• **Heath Suture Scissors**

- **Heath Suture Scissors**  
Serrated / 6 1/8" (15.5 cm)  
WS-413-22  
WS-413-22 Gold



• **Smith Wire Cutting Scissors**

- **1 blade serrated / straight / notched tip / 4 3/4" (12.1 cm)**  
WS-413-23



- **Heavy Synthetic Cast Shears**

- **Blunt tip / 9" (22.9 cm)**

WS-413-18  
WS-413-19TC

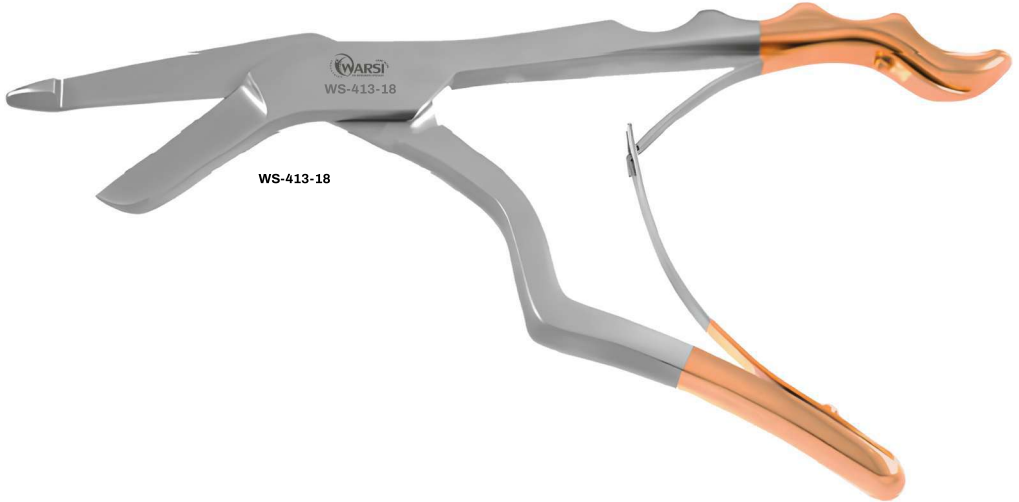

WS-413-18

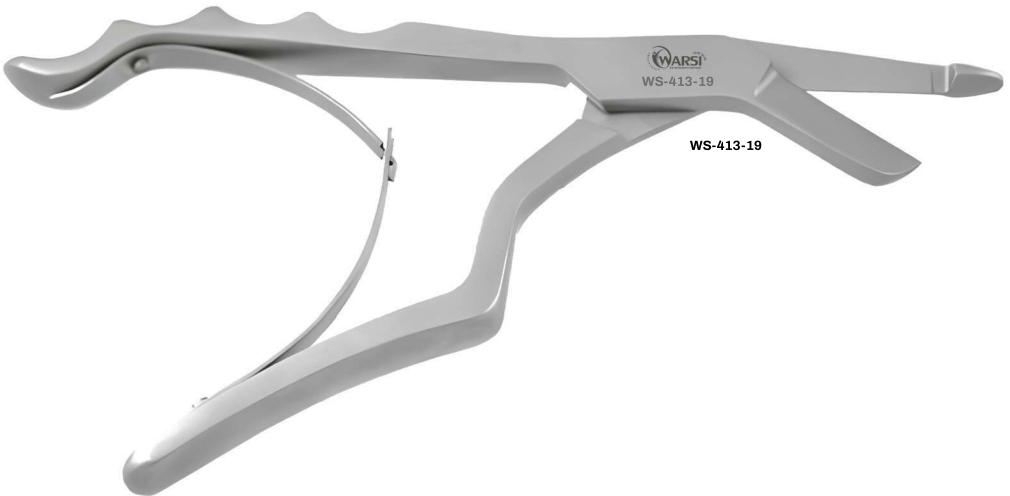

WS-413-19

• **Hercules Bandage/ Plaster Scissors**

- One serrated blade / 8" (19.5 cm)

WS-413-20  
WS-413-20c



• **Commander Utility Shears**

- One serrated blade / with wire cutter / 8" (19.5 cm)

WS-413-21  
WS-413-21 Gold



• **Knowles Bandage Scissors**

- Superior cutting ability / straight / 5 1/2" (14 cm)

WS-413-25 classic  
WS-413-26 PC gold

- Superior cutting ability / angled / 5 1/2" (14 cm)

WS-413-27 serrated  
WS-413-28 PC gold  
WS-413-29 PC black  
WS-413-30 TC/PC



• **Lister Bandage Scissors**

- CLASSIC
- GOLD
- PC BLACK

\*Please Contact If Any Modification Needed



WS-414-25

• **Classic**

- WS-414-21 3 1/2" (9 cm)
- WS-414-22 4 3/4" (12.1 cm)
- WS-414-23 5 1/2" (14 cm)
- WS-414-23L 5 1/2" (14 cm) left
- WS-414-24 6 1/4" (15.9 cm)
- WS-414-25 7 1/4" (18.5 cm)
- WS-414-26 8" (20 cm)
- WS-414-27 8" (20 cm) large double ring



WS-414-34

• **PC gold**

- WS-414-28 3 1/2" (9 cm)
- WS-414-29 4 3/4" (12 cm)
- WS-414-30 5 1/2" (14 cm)
- WS-414-30L 5 1/2" (14 cm) left
- WS-414-31 5 1/2" (14 cm) large double ring
- WS-414-32 6 1/4" (15.9 cm)
- WS-414-33 7 1/4" (18.5 cm)
- WS-414-34 8" (20 cm) large double ring
- WS-414-35 8" (20 cm)
- TC/PC
- WS-414-36 7 1/4" (19 cm)
- WS-414-37 5 1/2" (14 cm)
- WS-414-38 8" (20.3 cm)



WS-414-40

• **PC Black**

- WS-414-39 5 1/2" (14 cm)
- WS-414-40 7 1/4" (18.5 cm)
- WS-414-41 8" (20.3 cm) large double ring

• **Littauer Stitch Scissors**

- **Straight**  
WS-414-1 5" (12.5 cm)  
WS-414-2 5 1/2" (14 cm)

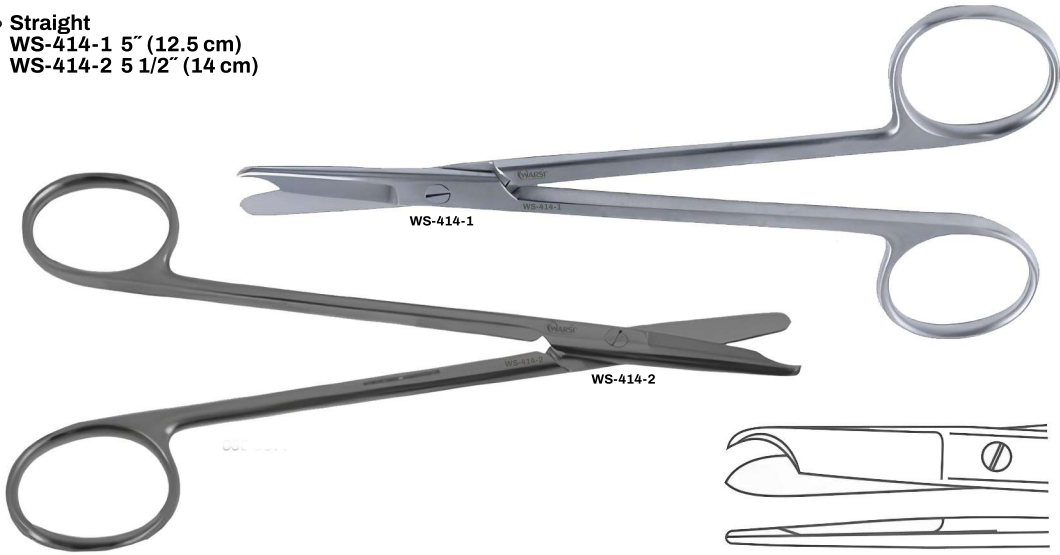

• **Knowles Bandage Scissors**

- **Superior cutting ability / straight / angled / serrated / rainbow / 5 1/2" (14 cm)**  
WS-414-3R  
WS-414-4

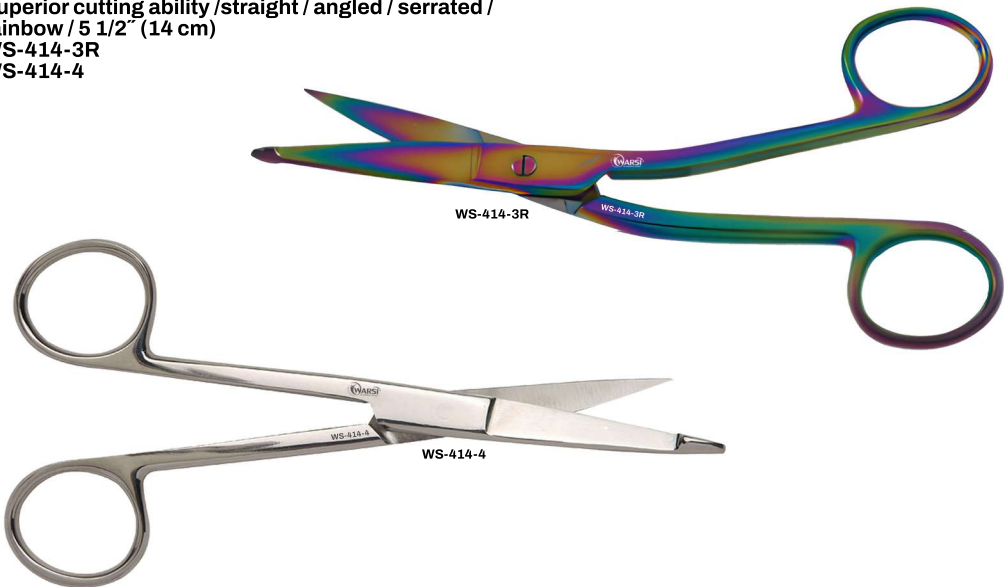

• **Nemetz Bandage Scissors**

- Curved / 3 1/2" (14 cm)  
WS-113-22

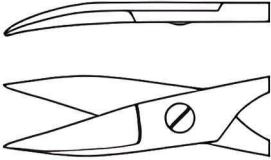

• **Harris Micro Bandage Scissors**

- One serrated blade / ball tip / 4 1/2" (11.5 cm)  
WS-113-23 straight  
WS-113-24 angled

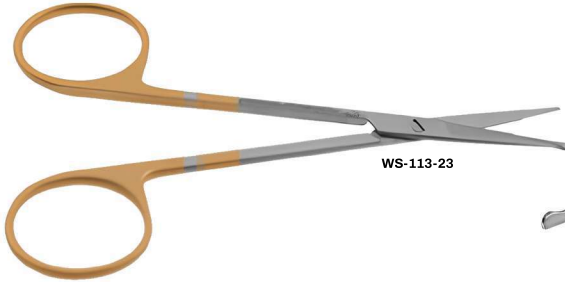

• **Taylor Bandage Scissors**

- Double-curved / PC gold / 5 1/2" (14 cm)  
WS-113-25  
WS-113-25 Gold



• **Reeh Stitch Scissors**

- Sharp / ribbon handle / 4" (10 cm)  
WS-832-5 curved



• **Northbent Stitch Scissors**

- Curved on flat / 4 3/4" (12 cm)  
WS-103-4

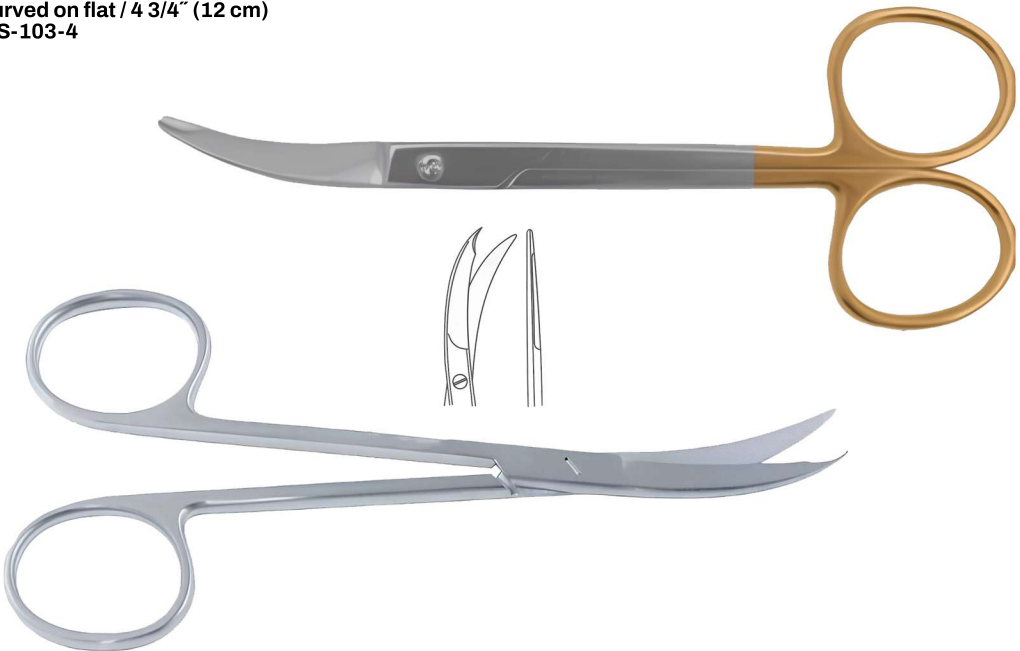

• **Spencer Suture Scissors**

• **3 1/2" (9 cm)**

- WS-295-1 straight
- WS-296-2 curved

• **4 1/2" (11.5 cm)**

- WS-296-3 straight
- WS-296-4D straight delicate
- WS-296-5 angled north bent



WS-295-1



WS-295-5

• **6" (15 cm)**

- WS-296-7 straight
- WS-296-8 angled north bent



WS-295-7

• **Spencer Suture Scissors**

• **3 1/2" (9 cm)**

- WS-110-2 straight
- WS-110-3 curved

• **4 1/2" (11.5 cm)**

- WS-110-4 straight
- WS-110-4D straight delicate
- WS-110-5 angled north bent



WS-110-2

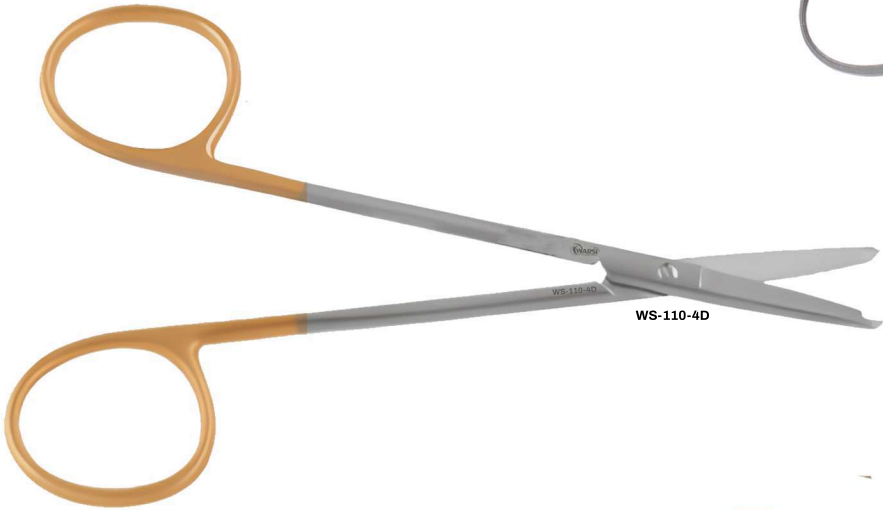

WS-110-4D

• **Curved / 4 3/4" (12 cm)**

- WS-110-6



WS-110-6

• **Wire Suture Scissors**

• **Serrated / 4 1/4" (10.5 cm)**

- WS-413-10 straight
- WS-413-10C curved

• **Curved / 4 3/4" (12 cm)**

- WS-413-11

• **Angled / 5" (12.5 cm)**

- WS-413-12 serrated
- WS-413-13 TC serrated

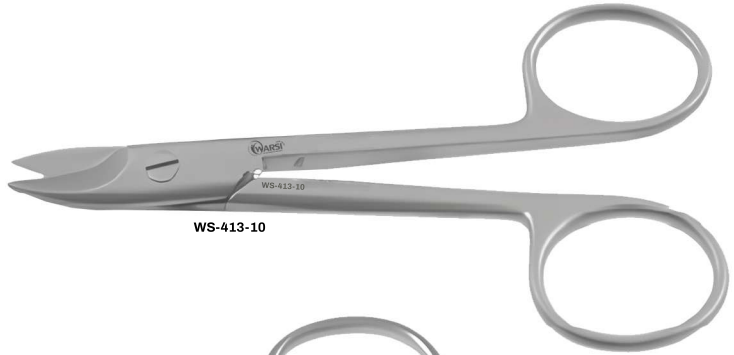

WS-413-10



WS-413-11

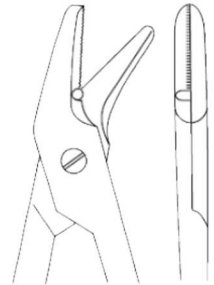

WS-413-12



# ORTHO MAYO SCISSORS



**Warsi® Scissors are simply unmatched in design, function, quality and variety. Sontec Scissors are offered in any model blade, shape or size in all of our model options listed below:**

• **Classic Model**

BH-113-41

- Combining extremely high quality with unmatched value
- Satin or high gloss finish

• **Tungsten Carbide - TC inserts**

Gold Rings

- diamond-ground tungsten-carbide inserts
- extremely sharp
- Blade hardness greatly increases scissor life
- available with or without serrations

• **Powercut blades® - PC gold**

Gold Rings with Stripes on Shanks

- sharpest cutting edge available
- serrated unless otherwise requested
- Finished in Sontec's Trademarked PC Gold design
- All the attributes of Sontec PC Black scissors

• **Powercut blades® - PC black**

Black Rings

- All the attributes of Sontec PC Gold
- Beautifully ornamented in black chrome

• **Tungsten Carbide / Power Cut - TC/PC:**

Gold Ring / Black Ring

- Serrated unless otherwise requested
- a combination of the best options
- HANDLE: one gold ring, one black ring
- This premier line encompasses TC long life, PC power, and Sontec Quality

• **Ceramic Coated Scissors:**

Black Ring

- offered to protect your investment even further by putting the instrument into an extremely hard coating which adds more life to your Sontec Scissors
- Offered in either PC or TC/PC models



• **Mayo Classic, Tungsten Carbide, Power Cut Gold, Power Cut Black®, TC/PC Power Cut®, Ceramitec Coated Scissors**

• **Classic beveled blades / straight / 5 1/2" (14 cm)**

WM-110-248 classic  
WM-110-272 TC  
WM-120-248 PC gold  
WM-120-726 PC black  
WM-120-539 TC/PC



WM-110-278 TC

• **Classic beveled blades / curved / 5 1/2" (14 cm)**

WM-110-254 classic  
WM-110-278 TC  
WM-120-254 PC gold  
WM-120-728 PC black  
WM-120-544 TC/PC

**Ceramitec coated / beveled blades / black with gold screw / PC / curved / 5 1/2" (14 cm)**

WM-120-960



WM-120-960 TC

• **Ceramitec coated / beveled blades / TC/PC curved blades / black with gold screw and gold shiny rings**

WM-120-962 5 1/2"  
WM-120-966 6 3/4"



WM-120-968 TC

• **Mayo Classic, Tungsten Carbide, Power Cut Gold, Power Cut Black®, TC/PC Power Cut®, Ceramitec Coated Scissors**

• **Classic beveled blades / straight / 6 3/4" (17 cm)**

- RM-100-250 classic
- RM-100-74 TC
- RM-200-50 PC gold
- RM-200-27 PC black
- RM-200-40 TC/PC

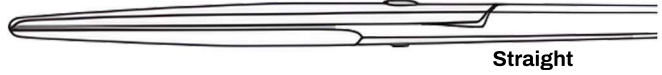

• **Classic beveled blades / curved / 6 3/4" (17 cm)**

- RM-100-56 classic
- RM-100-80 TC
- RM-200-56 PC gold
- RM-200-30 PC black
- RM-200-45 TC/PC

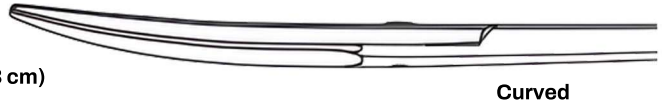

• **Classic beveled blades / PC / 7 1/2" (23 cm)**

- RM-400-06 straight
- RM-400-07 curved

• **Classic beveled blades / TC / 8" (20 cm)**

- RM-400-87 straight
- RM-400-88 curved

• **Classic beveled blades / PC / round handle / 8 1/4" (21 cm)**

- RM-400-31 straight
- RM-400-32 curved

• **Classic beveled blades / TC / 9" (23 cm)**

- RM-400-89 straight
- RM-400-90 curved



• **Mayo Classic, Tungsten Carbide, Power Cut Gold, Power Cut Black®, TC/PC Power Cut®, Ceramitec Coated Scissors**

• **Round blades / straight / 5 1/2" (14 cm)**

- RM-110-26 classic
- RM-1100-22 R TC
- RM-2400-91 PC gold

**Round blades / curved / 5 1/2" (14 cm)**

- RM-110-29 classic
- RM-1100-78R TC
- RM-2400-92 PC gold

**Round blades / TC/PC / 5 3/4" (14.25 cm)**

- RM-1200-42 straight
- RM-1200-47 curved

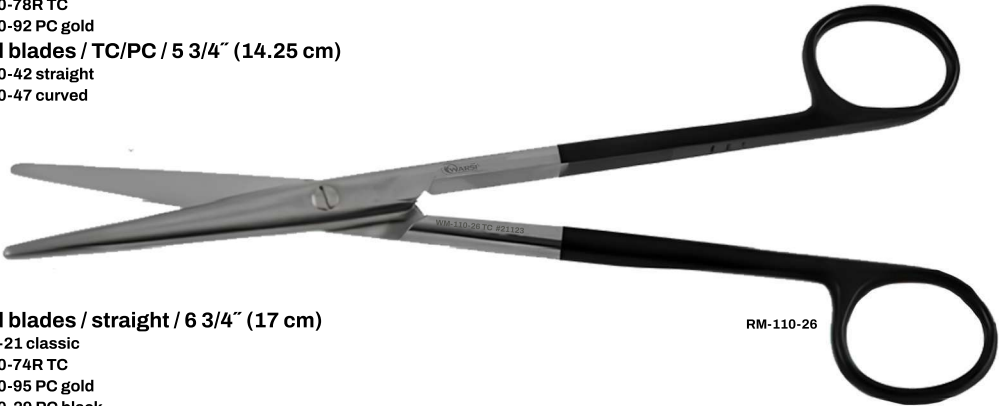

RM-110-26

• **Round blades / straight / 6 3/4" (17 cm)**

- RM-110-21 classic
- RM-1100-74R TC
- RM-2400-95 PC gold
- RM-1200-29 PC black
- RM-1200-50 TC/PC

**Round blades / curved / 6 3/4" (17 cm)**

- RM-110-72 classic
- RM-1100-80R TC
- RM-2400-97 PC gold
- RM-1200-31 PC black
- RM-1200-51 TC/PC

**Round blades / PC Gold / 7 1/2" (23 cm)**

- RM-2400-98 straight
- RM-2400-99 curved

**Round blades / PC Black / 7 1/2" (23 cm)**

- RM-2400-01 curved
- RM-2400-03 straight

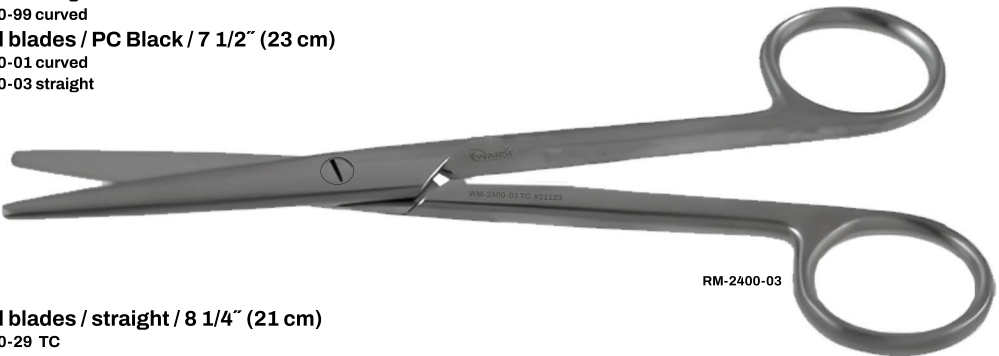

RM-2400-03

• **Round blades / straight / 8 1/4" (21 cm)**

- RM-2400-29 TC
- RM-2400-31 PC gold

**Round blades / curved / 8 1/4" (21 cm)**

- RM-2400-30 TC
- RM-2400-32 PC gold

- **Mayo Classic, Tungsten Carbide, Power Cut Gold, Power Cut Black®, TC/PC Power Cut®, Ceramitec Coated Scissors**

- **Round blades / PC black / 8 1/4" (21 cm)**  
RW-400-16S straight  
RW-400-18C curved



RW-400-18C

- **Round blades / PC Gold / 9" (23 cm)**  
RM-400-33S straight  
RM-400-34C curved



RW-400-34C



# ORTHOPEDIC BONE HOOKS

• **McMinn Dislocating Hook**

- McMinn Dislocating Hook  
25cm/10" length  
Blunt hook with Tufnol handle  
WR-288-26



• **Mandible Bone Hook**

- 8" (20 cm)  
320-937  
WR-288-27



• **Warsi® Bone Hook**

- 9" (23 cm)  
WR-288-28 small  
WR-288-29 medium  
WR-288-30 large



• **Bone Hook Sharp**

- **Bone Hook Sharp**  
24.5cm/9¾" length  
Sharp  
WR-288-31



• **Blunt Hook**

- **Blunt Hook**  
20cm/8" length  
WR-288-32



• **Wroblenski Dislocating Hook**

- **Wroblenski Dislocating Hook**  
25cm/10" length  
For hooking around the neck of the Femur  
WR-288-33





# ORTHOPEDIC RETRACTORS



• **West's S/R Retractor**

• **West's S/R Retractor**

14cm/5½" length  
3x4 Sharp prongs  
SR-4303-14

**Weitlaner S/R Retractor**

14cm/5½" length  
3x4 Blunt prongs  
SR-4303-15

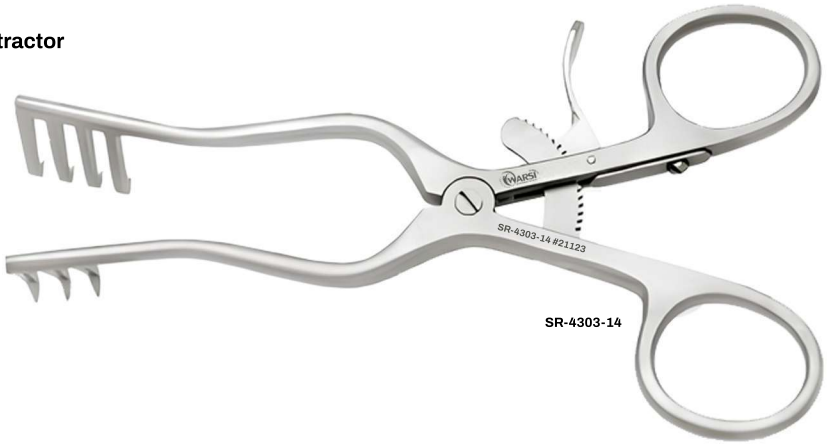

• **Travers S/R Retractor**

• **20cm/8" length**

4x5 Blunt prongs  
SR-4304-20



• **Norfolk and Norwich S/R Retractor**

- **20cm/8" length**
- **4x5 Blunt prongs**
- **SR-400-220**



SR-400-220

• **Gelpi Laminectomy Retractor**

- **Sharp prongs**
- **Length Prong depth**
- **18.5cm/7¼" 30mm**
- **19.5cm/7¾" 50mm**
- **20cm/8" 70mm**
- **SR-400-221**



SR-400-221

• **Charnley Vertical Retractor**

- 24.5cm/9½" length
- 3x4 Sharp prongs
- Blade depth 22mm
- SR-407-26



• **Cones Self Retaining Retractor**

- 3x4 Prongs
- Jointed arms
- SR-407-27

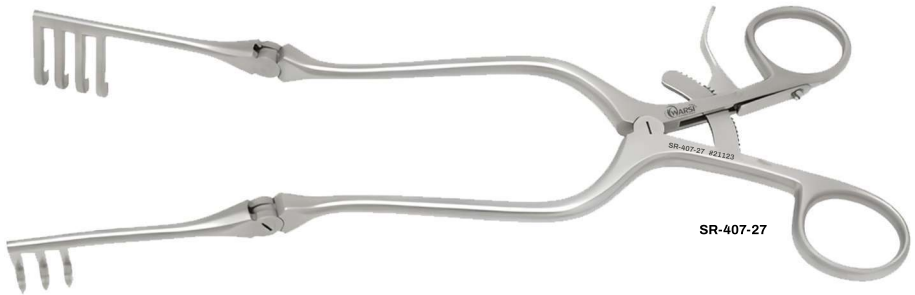

• **Harvey Jackson Self Retaining Retractor**

- 30.5cm/12" length
- Blade depth 45mm
- 3x3 Sharp prongs
- SR-407-30



• **Charnley Horizontal Hip Retractor**

- 28cm/11" length
- Blade depth 18mm
- Hinged joint
- 7" opening
- SR-406-8



• **Hardinge Horizontal Retractor**

- Blade depth 18mm
- Hinged joint
- SR-406-9



• **Charnley Pin Retractor**

- Complete set with:
  - T-handle introducer
  - Pair of pins with chains
  - SR-110-00
  - SR-102-00 Pair of pins with chain only
  - SR-101-00 T-handle only

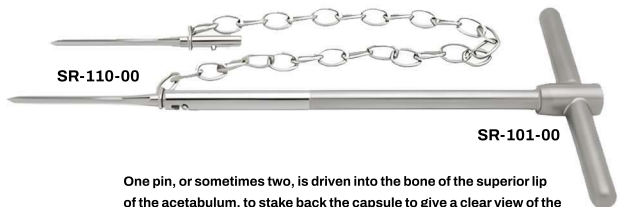

One pin, or sometimes two, is driven into the bone of the superior lip of the acetabulum, to stake back the capsule to give a clear view of the superior lip of the acetabulum. The nerve supply to the tensor fasciae femoris is preserved in this exposure by restricting dissection in the cleft in front of the gluteus medius, but this restricts exposure. By using pins to stake back the abductor muscles, a good exposure of the acetabulum can be obtained, and at the same time the nerve supply to tensor fasciae femoris can be preserved.

The short pins do not obstruct the surgeon's hand in access to the acetabulum. The chain is a safety device to prevent the pins being left in situ.

• **Viper Hinged Scoliosis Retractor**

• **30cm/11¾" length / Sharp**

Depth Prongs

SR-78-38H 40mm

SR-78-40H 70mm

SR-78-50H 100mm

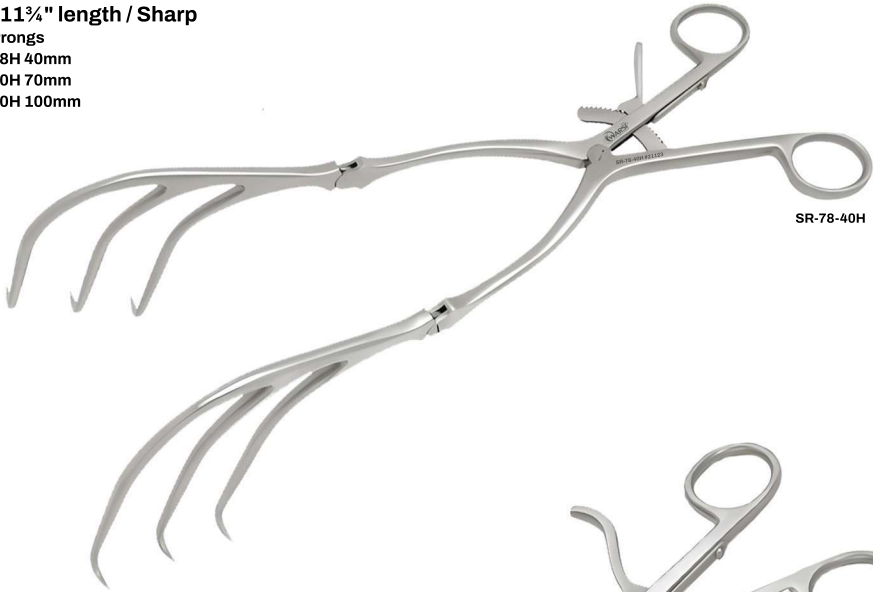

• **Viper Scoliosis Retractor**

30cm/11¾" length

Sharp prongs

Depth Prongs

SR-78-38 40mm

SR-78-40 70mm

SR-78-50 100mm

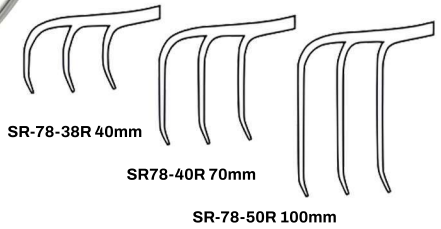
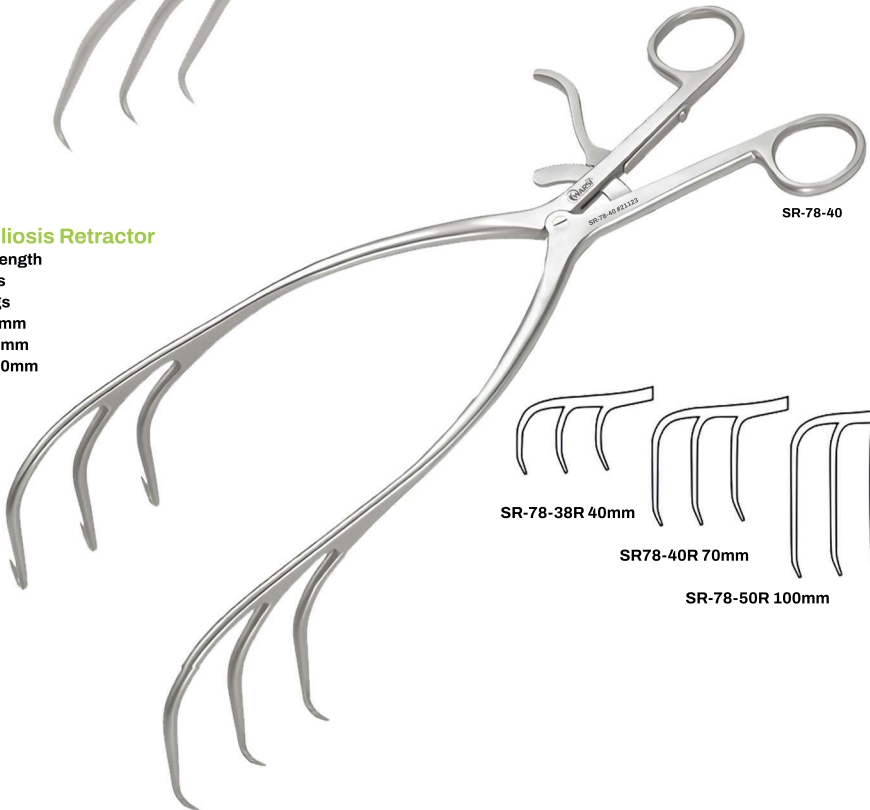

### • Howarth Elevator

- 21.5cm/8½" length  
SP906-0431



### • MacDonal Elevator/Dissector

- HA705-19 19cm/7½"  
SP906-23 23cm/9"



### • Watson Cheyne Dissector

- HA23-18 18cm/7"  
SP23-23 23cm/9"  
SP20-25 25.5cm/10"



### • Freers Elevator/Dissector

- 18.5cm/7¼" length  
SP906-0432



### • Swedish Dissector

- 18cm/7" length  
SP906-0433





# HIPS JOINT INSTRUMENTS

• **Femoral Head Impactor**

- 20cm/8" length  
Nylon head  
WT-434-43

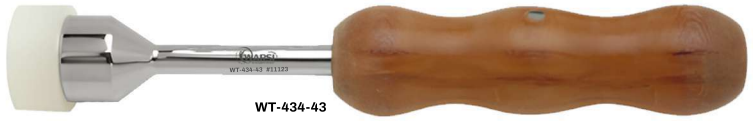

• **McGoey Bone Punch**

- Double ended
- Double ended  
WT-434-46

\* illustrated

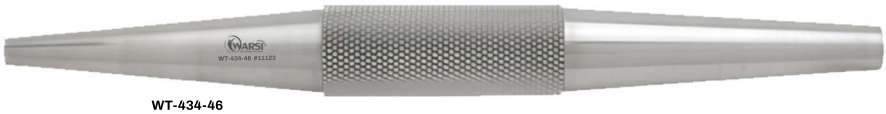

No 1. 13mm x 19mm Ø SP6913-19 Large size



No 2. 6mm x 10mm Ø SP6906-10 \*Small size



No 3. 6mm x 13mm Ø SP6906-13 With flats



• **Hardinge Cement Restrictor**

- 33.5cm/13 $\frac{3}{4}$ " length  
Graduated shaft  
WT-354-44



• **Femoral Pusher**

- Square ended  
WT-354-45





# ORTHOPEDIC ROUNGERS



• **Beyer Rongeur**

- Double-action / curved / 7" (18 cm)  
DD5-97 2.3 mm jaw  
DD5-98 3.0 mm jaw  
DD5-99 4.0 mm jaw

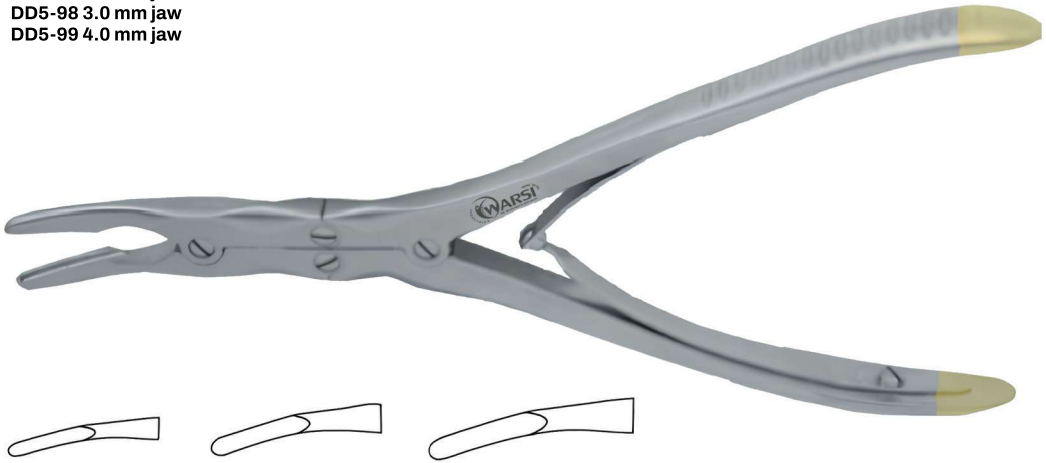

• **Smith-Peterson Warsi Streamlined Laminectomy Rongeur**

- Unique delicate shape / modified model / double action / curved / 3 mm jaw / 7 1/2" (19 cm)  
DD5-91



• **Beyer Rongeur**

- **Double-action / curved / 7" (18 cm)**  
DD5-97 2.3 mm jaw  
DD5-98 3.0 mm jaw  
DD5-99 4.0 mm jaw

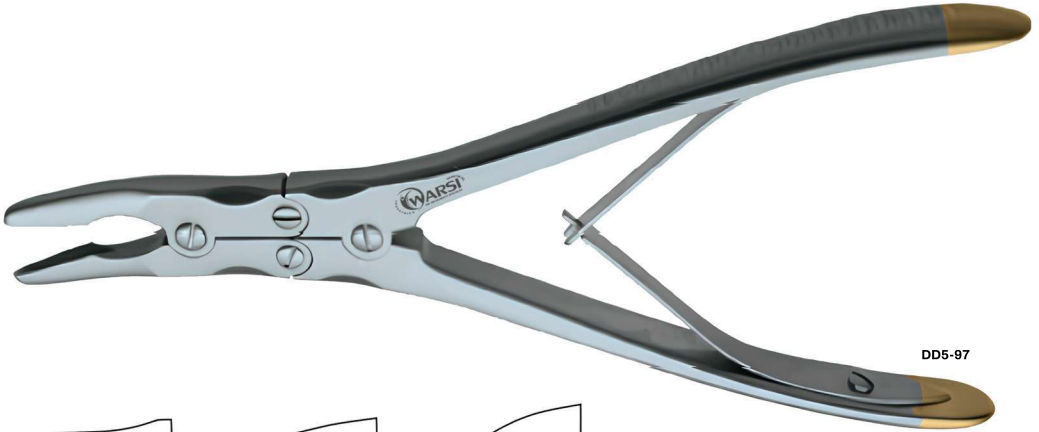

DD5-97



straight



slight curve

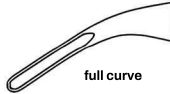

full curve



DD5-98

• **Black Ruskin Rongeur**

- **Black Ruskin Rongeur**  
Curved / double action / ceramic coated / 4 mm / 7 1/4" (18.5 cm)  
WS-315-95



• **Kleinert-Kutz Duckbill Synovectomy Rongeur**

- **Double action / 2 mm x 10 mm jaw / curved to side / 6" (15.5 cm)**  
WS-315-22



• **Ruskin Rongeur**

• **Double action / 6" (15.5 cm)**

- WS-315-55 2 mm jaw str
- WS-315-57 2 mm jaw cvd
- WS-315-50 3 mm jaw str
- WS-315-58 3 mm jaw slight curve
- WS-315-59 3 mm jaw full curve
- WS-315-56 4 mm jaw str
- WS-315-53 4 mm jaw cvd



WS-315-58

• **Double action / 7 1/4" (18.5 cm)**

- WS-315-61 5 mm jaw str
- WS-315-62 5 mm jaw cvd
- WS-315-63 mm jaw str
- WS-315-64 6 mm jaw cvd



WS-315-62

• **Double action / 5 mm / 9 1/2" (23.1 cm)**

- WS-315-69 str
- WS-315-70 cvd



WS-315-69

• **Ruskin Duckbill Rongeur**

- **Double action / 5 mm jaw / curved to side / 7 1/4" (18.5 cm)**  
WS-315-60



• **Zaufel-Jansen Rongeur**

- **Double-action / 4 mm jaw / 7" (18 cm)**  
WS-315-61





# HIPS REVISION INSTRUMENTS

● **Bayonet Cement Gouge**

- 40cm/15½" length
- Tufnol handle with strike plate
- Width 5mm to 10mm
- WC-565-6



● **Bayonet Cement Gouge**

- 40cm/15½" length
- Tufnol handle with strike plate
- Width 5mm to 10mm
- WC-565-7



● **Malleable Cement Probe**

- 38cm/15" length
- For probing the Femur
- WC-565-8



● **Cement Plug Extractor**

- 48cm/19" length
- T-handle
- For extraction of cement plug
- Width 5mm to 11mm



### • Bayonet Cement Gouge

- 40cm/15¾" length
- Tufnol handle with strike plate
- SP-4416-26



### • Bayonet Cement Gouge

- 40cm/15¾" length
- Tufnol handle with strike plate
- SP-4416-25



### • Cement Splitting Osteotome

- 30cm/12" length
- Tufnol handle with strike plate
- Guarded blade 5mm to
- SP-4416-24



### • Straight Cement Gouge

- 30cm/12" length
- Tufnol handle with strike plate
- Width 5mm to 10mm
- SP-4416-23



### Cup Extraction Chisel

- 32cm/12½" length
- Curved 7mm tip
- Metal strike plate
- Tufnol handle
- SP-4516-23



### Bayonet Gouge

- 32cm/12½" length
- Metal strike plate
- Tufnol handle
- 8mm width
- SP-4516-24



### Swan Necked Gouge

- 28.5cm/11" length
- 25mm width
- SP-4516-26



### Cement Gouge

- 34.5cm/13½" length
- 9mm - 11mm Width
- SP-4516-27



### Femoral Head Extractor

- 23cm/9" length
- Tufnol handle
- SP6916-23



SP6916-23

### Moore Femoral Head Extractor

- 20.5cm/8" length
- Metal handle
- SP6916-24

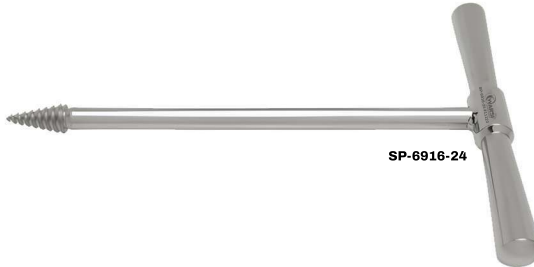

SP-6916-24

### Joint Capsule Clamp

- 21cm/8¼" length
- 25mm jaw length
- SP6995-21

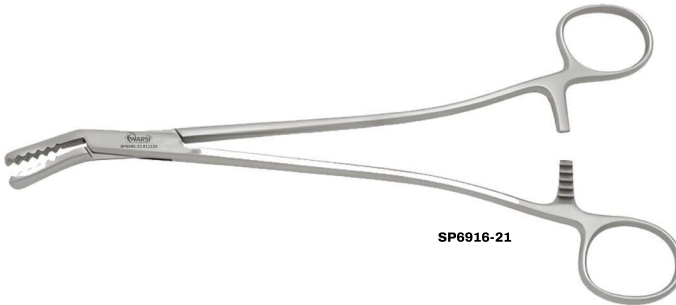

SP6916-21

### Joint Capsule Scissors

- 25cm/9¾" length
- Angled blades
- SP6910-25



SP6916-25

• **Fine Cement Duckbill Grasping Forceps**

- 35cm/14" shaft length
- Fine jaws
- WC-346-74



• **Heavy Cement Grasping Forceps**

- 26cm/10" shaft length
- Serrated jaws 6mm width
- WC-346-75



### • Bayonet Cement Rasp

- 52cm/20½" length
- Tufnol handle
- WC-346-101



V-shape



Strong round shape\*



Flat round curve

### • Bayonet Cement Chisel

- 40cm/15¾" length
- Tufnol handle with strike plate
- Width 5mm to 10mm
- WC-346-102



### • Bayonet Cement Splitting Osteotome

- 40cm/15¾" length
- Tufnol handle with strike plate
- Guarded blade
- Width 5mm to 10mm
- WC-346-103



### • Retrograde Cement Chisel

- 50cm/19 3/4" length
- Tufnol T-handle
- Striking plate
- 5mm to 10 mm Width
- WC-346-76

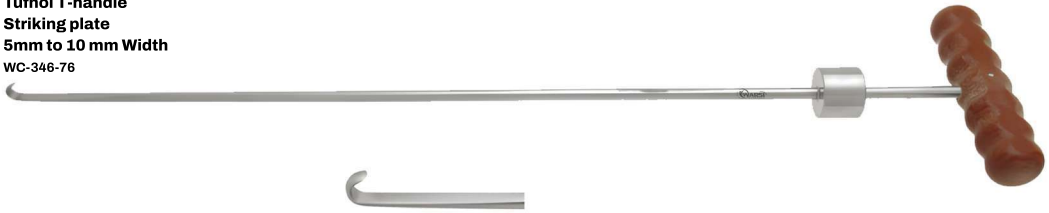

### • Slotted Mallet

- SP-850-010



### • Cement Extraction Hook

- 34.5cm/14" length
- WC-346-77



### • Cement Twist Drill Long

- 40cm/15 3/4" length
- Diameter 6mm to 10 mm
- WC-346-78
- WC-346-78A
- WC-346-78B





# ORTHOPEDIC CHISELS

• **Hibbs Chisel**

- **Curved / 7 1/4" (18.4 cm)**  
222-460 7 mm



• **Straight / 7 1/4" (18.4 cm)**

- 222-462 6 mm
- 222-464 8 mm
- 222-466 10 mm
- 222-468 12 mm
- 222-470 16 mm
- 222-472 22 mm



• **Chisel with Interchangeable Blades**

- **20cm/8" length**

Tufoal handle  
Very thin blades  
Blade Width

- SH-43-05 5mm\*
- SH-43-08 8mm
- SH-43-10 10mm\*
- SH-43-12 12mm
- SH-43-15 15mm\*
- SH-43-25 25mm\*



• **Hibbs Chisel**

• **Straight / 9 1/2" (24.1 cm)**

- 222-00 1/4"
- 222-11 3/8"
- 222-12 1/2"
- 222-13 5/8"
- 222-14 3/4"
- 222-15 7/8"
- 222-16 1"
- 222-17 1 1/8"
- 222-18 1 1/4"
- 222-19 1 1/2"



• **Curved / 9 1/2" (24.1 cm)**

- 222-00C 1/4"
- 222-11C 3/8"
- 222-12C 1/2"
- 222-13C 5/8"
- 222-14C 3/4"
- 222-15C 7/8"
- 222-16C 1"
- 222-17C 1 1/8"
- 222-18C 1 1/4"
- 222-19C 1 1/2"



• **Box Chisel**

- **29cm/13 1/2" length**
- **For preparation of the proximal femur**
- **31mm width x 6mm**
- **222-465**





# ORTHOPEDIC SAW



• **Joseph Bone Saw**

- Single-sided / 7 1/2" (19 cm)  
WS-100-66



WS-100-66

• **Joseph Bayonet Bone Saw**

- Single-ended / single-sided / 8" (20.5 cm)  
WS-45-55 right  
WS-45-56 left  
WS-45-57 set: including one right & one left



WS-45-55



WS-45-56

• **Gigli Saw Blade Handle**

- Available in pairs
- WS-00-506 loop style
- WS-00-508 T-Handle
- WS-00-503 blade 12" (30 cm)
- WS-00-504 blade 20" (51.5 cm)
- WS-00-505 blade 30" (76 cm)

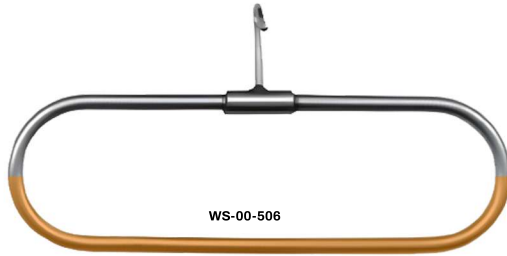

• **Cottle Bone Saw**

- AKA Patella Bone Saw / Delrin handle  
WS103-220-SET includes handle and blade  
WS103-221 replacement blade only  
WS103-219 handle only

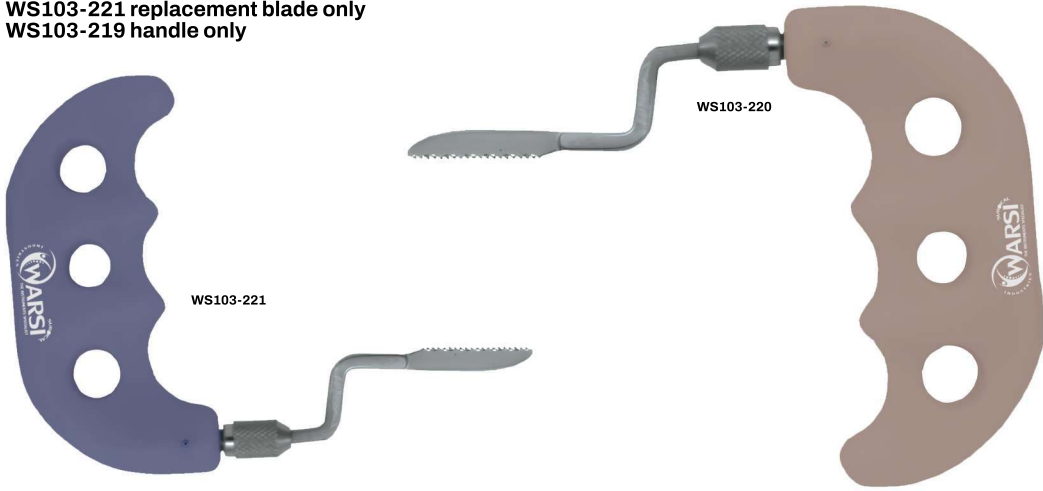

• **TPLO Aluminum Saw**

- WS45-258 TPLO aluminum saw with replaceable 5 1/2" blade  
WS45-258B replaceable blade  
WS45-258H handle with wrench



• **Cloward Vertebral Cervical Spreader Retractor**

• **WS-16-137**



WS-16-137

• **Cloward Lamina Spreader**

• **WS-52-130 6 1/4" (15.9 cm)**



WS-52-130



# PIN PULLER & BENDERS



• **Vickers Easy Driver / Bender / Puller**

- To drive, bend & pull K-wire / 5 1/2" (14 cm)  
PP03-79  
PP03-79G



• **Black Vickers K-Wire Pin Bender**

- 3 1/2" (9 cm)  
 PP03-78A 1 mm Ø (0.035") x 1.2 mm Ø (0.045")  
 PP03-78C 1.4 mm Ø (0.054") x 1.6 mm Ø (0.062")



PP03-78A



PP03-78C

• **Pin Driver & Bone Tamp**

- Single-ended flat tip with 1 mm raised circular lip / 3 1/2" (9 cm) in length

- PP03-011 1.5 mm tip
- PP03-01A 2 mm tip
- PP03-01B 3 mm tip
- PP03-01C 4 mm tip
- PP03-01D 5 mm tip
- PP03-01E 6 mm tip
- PP03-01F 8 mm tip
- PP03-01G 10 mm tip



PP03-01E



PP03-011

PP03-01 #21323

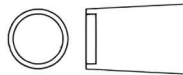

PP03-01E

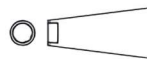

PP03-011

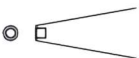

PP03-01A

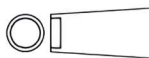

PP03-01B



PP03-01C

• **Warsi Pin Driver / Bender**

• **Bends K-wire and pins**

PP103-01 2 mm / 2.3 mm 5" (13 cm)

PP106-99 2 mm / 3.2 mm 6" (15.5 cm)

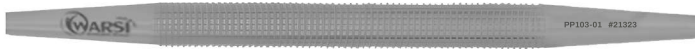

PP103-01



PP106-99

• **Peterson Fully Cannulated Pin Bender**

• **Double-ended with concave tips / specially cannulated through entire length for better leverage**

PP03-21J 2 mm tip / 2.3 mm tip 5" (13 cm)

PP03-21H 2 mm tip / 3.2 mm tip 5 3/4" (14 cm)



PP03-21J



PP03-21H

- **Pin Bender Double-Ended**

- Bends K-wire / 4 1/2" (11.5 cm)  
PP06-196 1.6 mm tip / 2.0 mm tip  
PP06-198 0.8 mm tip / 1.25 mm tip



PP06-196



PP06-198

- **Pin Bender Double-Ended**

- Bends K-wire / 0.9 mm (0.035") / 1.6 mm (0.062") / 1.1 mm (0.045") / 1.4 mm (0.054") / 4 1/2" (11.5 cm)  
PP06-206



PP06-206



# BONE HOLDING

Bone holding instruments are used during medical and surgical procedures to manipulate, hold, and support skeletal structures such as the skull, vertebrae, ribs, and long bones. They are commonly used to set or maintain fractures, reduce dislocations, and support tissues during surgery.

[www.warsisurgical.com](http://www.warsisurgical.com)





# BONE HOLDING CLAMPS

• **Verbrugge Bone Clamp**

• **Ring handle / with ratchet**

BH-240-V3 7" (18 cm)

• **Reverse jaw / curved to side / with speedlock**

BH-020-R1 4" (10 cm)

BH-020-R2 6" (15.5 cm)

BH-020-R3 7 1/2" (19 cm)

BH-020-R4 8 1/4" (21 cm)

BH-020-R5D 8 1/4" (21 cm) delicate

BH-020-R5 10" (25.5 cm)

• **Reverse speed lock and jaw / curved to side**

BH-010-L1 3/4" (15 cm)

BH-010-L2 8" (20.5 cm)

BH-010-L3 9" (23 cm)

BH-010-L4 10 1/4" (26 cm)

BH-010-L5 1/4" (29 cm)



• **Verbrugge Bone Clamp**

• **Curved to side / with speedlock**

- BH-070 6" (15.5 cm)
- BH-074 7 1/2" (19 cm)
- BH-075 8 1/4" (21 cm)
- BH-075D 8 1/4" (21 cm) delicate
- BH-080 10" (25.5 cm)

• **Swivel jaw / curved to side**

- BH-071 5 3/4" (15 cm)
- BH-073 8" (20.5 cm)
- BH-077 9" (23 cm)
- BH-078 10 1/4" (26 cm)
- BH-079 11 1/4" (29 cm)



• **Warsi Ulrich Bone Clamp**

• **Straight / with speedlock**

BH-367-S1\* 7 1/8" (18.25 cm)

BH-367-S2 9" (23 cm)

BH-367-S3 10 1/2" (27 cm)

• **Curved to side / With speedlock**

BH-305-L1 5 1/4" (13.5 cm)

BH-365-L2\* 5 1/2" (14 cm)

BH-366-L3 6 1/2" (16.5 cm)

BH-367-L4\* 7 1/8" (18.25 cm)

BH-368-A1 9" (23 cm)

BH-369-A2 10 1/2" (27 cm)

\* micro jaws



• **Kern Bone Clamps**

• **Fenestrated jaw / with ratchet**

- BH-018-C2 4 3/4" (12 cm)
- BH-018-C3 5 1/2" (14 cm)
- BH-018-C4 6 1/4" (15.9 cm)
- BH-018-C5 7" (18 cm)
- BH-018-C6 8 1/2" (21.5 cm)

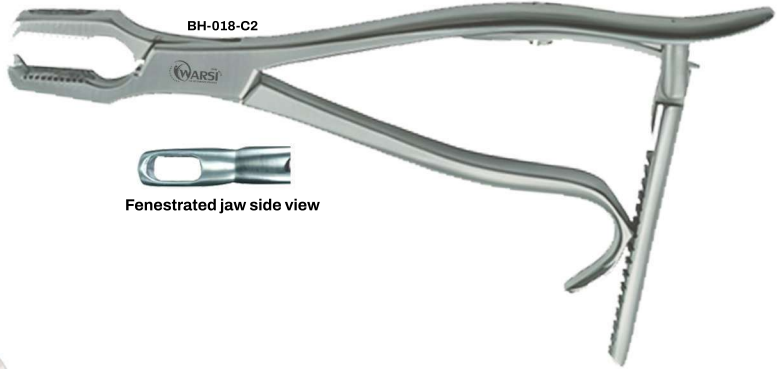

• **Stefan Mini Bone Holding Forceps**

- **Curved / 4 mm opening / mini**
- BS-1103-F1 4" (10 cm) with speedlock
- BS-1103-F2 4" (10 cm) with ratchet
- BS-225-S4 5 1/2" (14 cm) with ratchet



BS-1103-F1

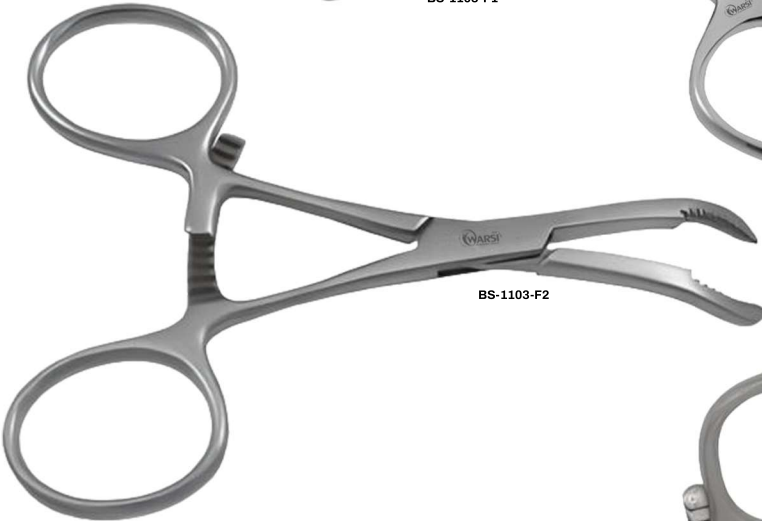

BS-1103-F2

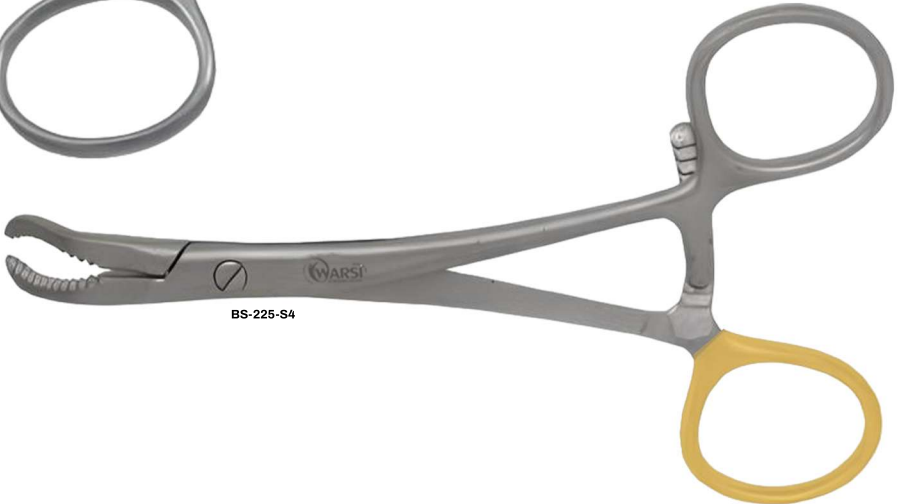

BS-225-S4

• **Stefan Bone Holding Forceps**

- **Curved / with speed lock**
- BS-110-S1 5 1/2" (14 cm)
- BS-110-S2 6" (15.5 cm)
- BS-250-S3 7" (18 cm)
- BS-110-S5 9 1/2" (24 cm)



BS-250-S3

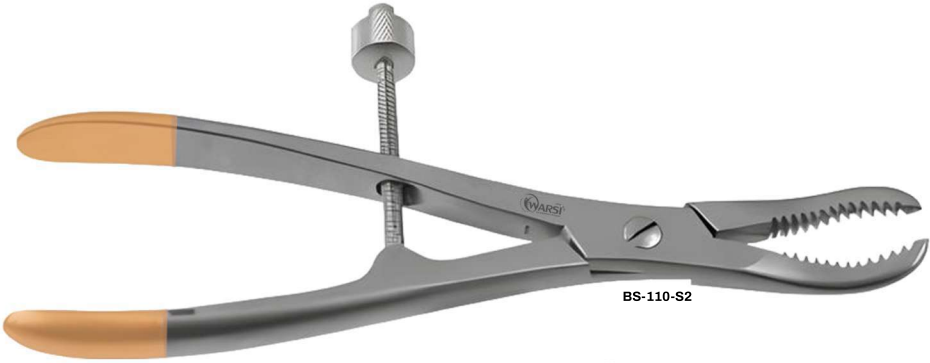

BS-110-S2



BS-110-S1

- **Sequestrum Warsi Bone Forceps**

- **Serrated jaws / 8" (20.3 cm)**

BH-0130-S straight  
BH-0140-C curved



- **Angus Bone Holding Clamp**

- Round serrated jaws / with ratchet /  
BH-270-A1 5 3/4" (14.6 cm)

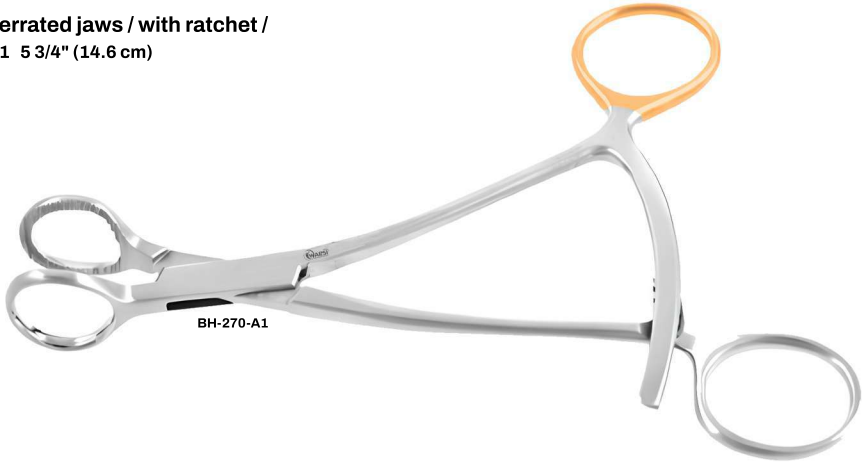

- **Angus Bone Holding Forceps**

- 6" (15.5 cm)  
BH-03-015 with ratchet  
BH-03-017 with speedlock

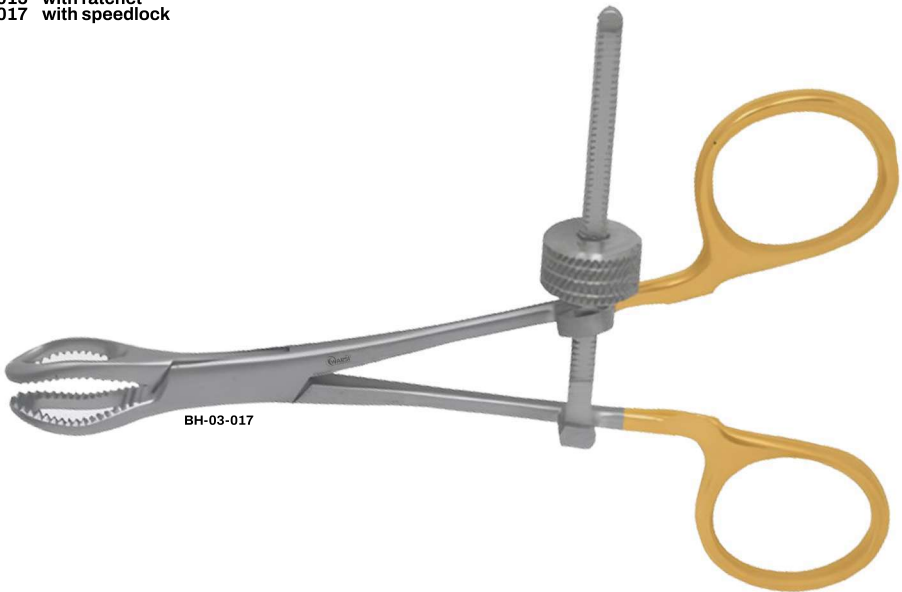

• **Taylor-Dingmann Bone Clamp**

- angled / 7 1/2" (19 cm)

BH-130-P1 With Ratchet  
 BH-130-P2 with speedlock  
 BH-130-P3 with ratchet

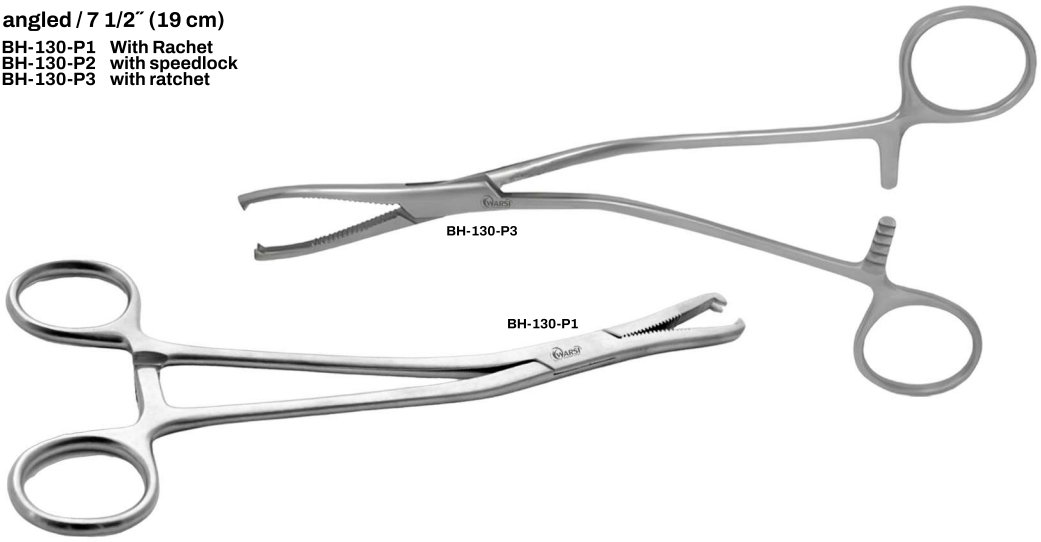

• **Sesamoidectomy Bone Clamp**

- Strong curve with ratchet

BH-131-P3 6 1/2" (16.5 cm) / with ratchet  
 BH-131-P4 6 1/2" (16.5 cm) / with ratchet

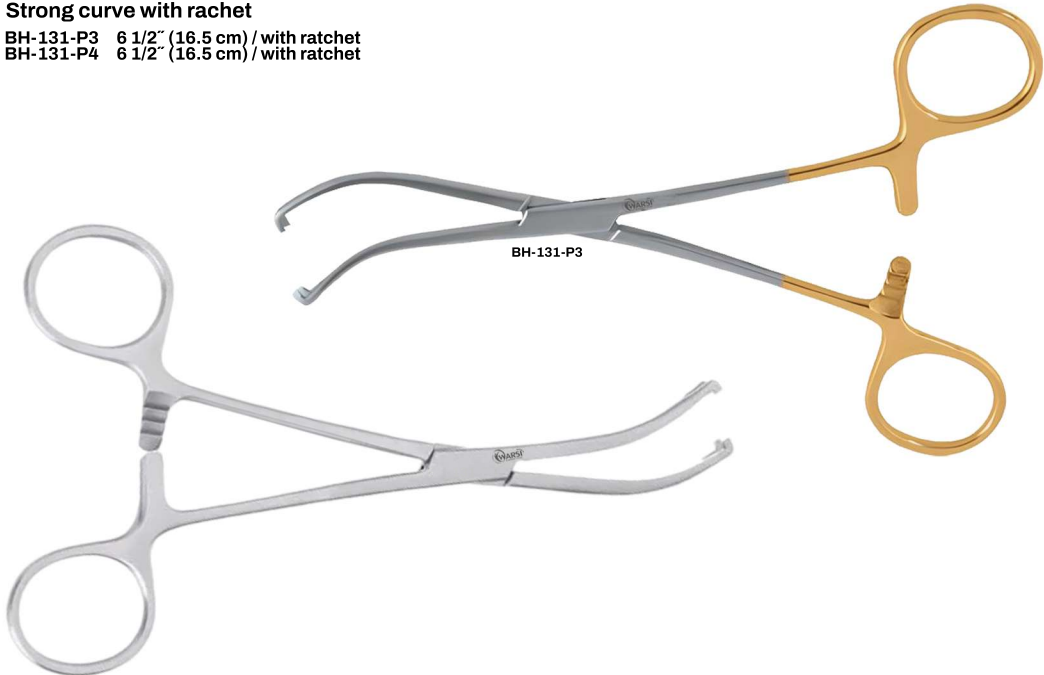

- **Babcock Bone Holding Clamp**

- **Angled / with ratchet**  
BH-1103-J1 / 7 3/4" (19.7 cm)

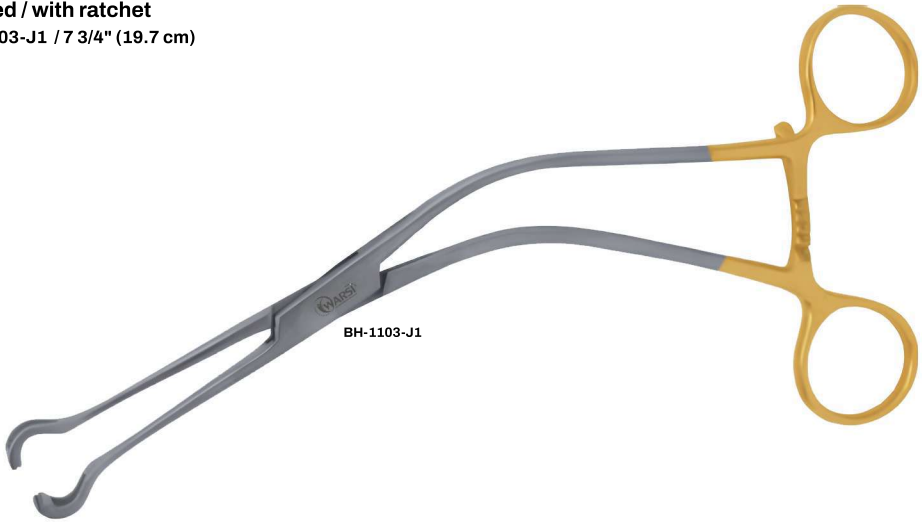

- **KUV Richards Bone Clamp**

- **With ratchet**  
BH-1103-K1 / 9" (23 cm)

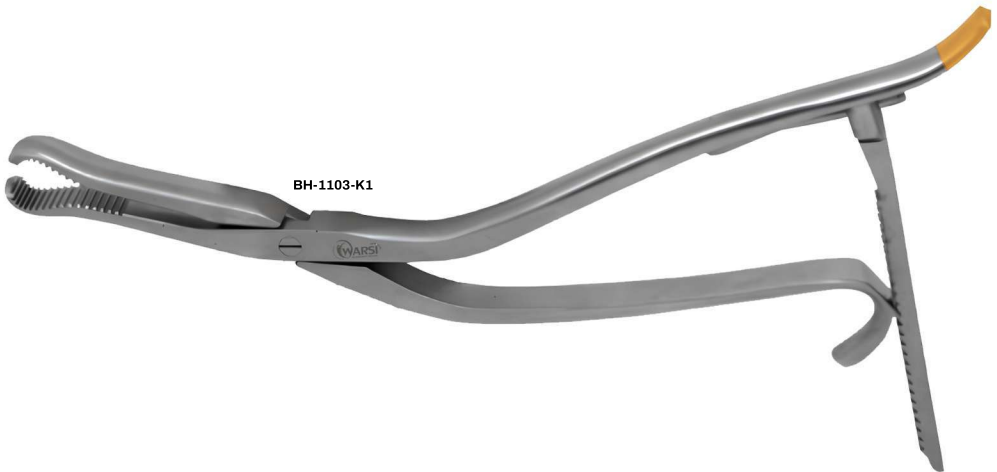

• **Mini Doolen Bone Holding Clamp**

• **Mini Doolen Bone Holding Clamp**

- BH-843-1 with speedlock
- BH-844-2 with ratchet

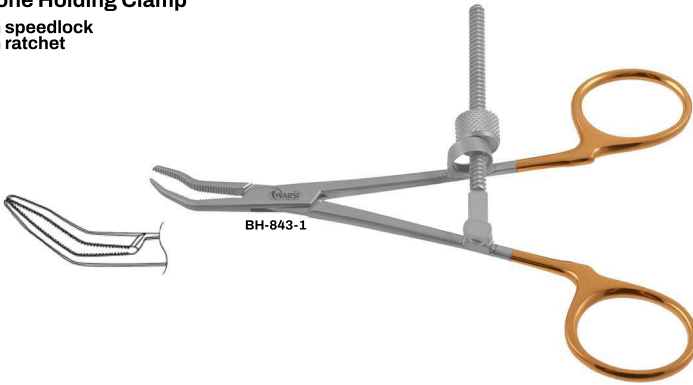

• **Doolen Bone Holding Clamp**

• **2mm wide jaw / 5.5" (14cm)**

- BH-1103-R1 str w/ speedlock
- BH-1103-R2 ang w/ speedlock
- BH-1103-R3 ang w/ ratchet

• **3mm wide jaw / angle jaw / 7" (18 cm)**

- BH-1103-R4 with speedlock
- BH-1103-R5 with ratchet

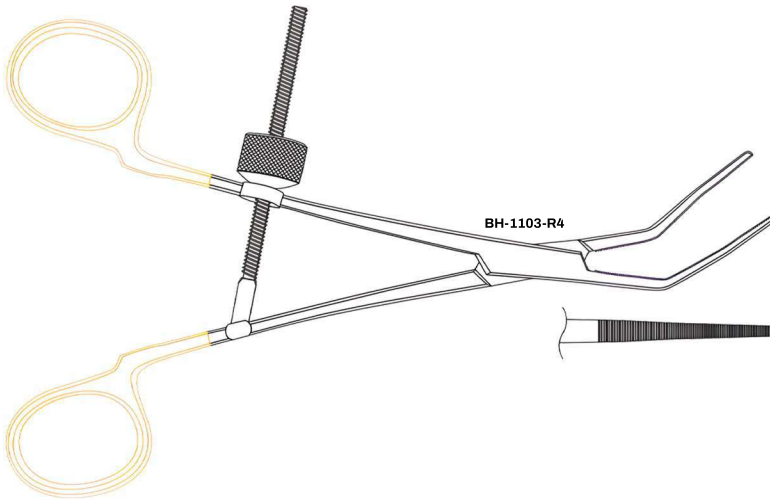
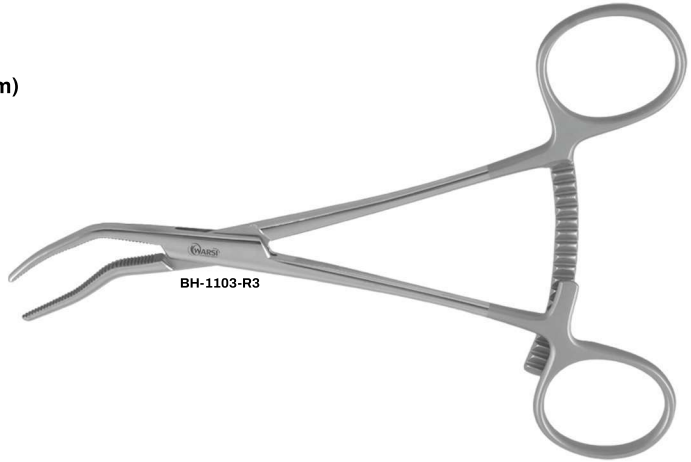

- **Kern Hybrid Bone Clamp**
- **With speedlock / fenestrated head**  
BH-305-A01 4 3/4" (12 cm)

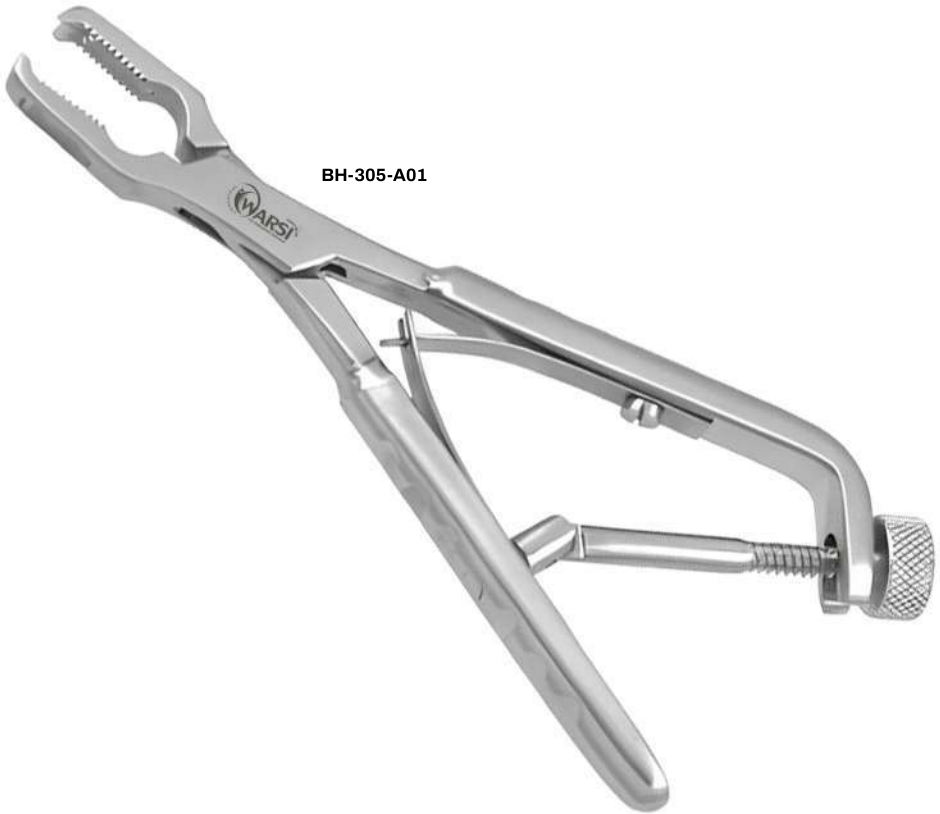

- **Bishop Bone Clamp**

- **With ratchet**

BH-305-C8 12 1/2" (31.8 cm)



- **Patella 2 x 2 Prong Bone Clamp**

- **With speed lock**

BH-1104-O1 7 1/4" (18.5 cm)



• **Lowman Bone Holding Clamp**

• **1 x 1 prongs**

- BH-016-01 4 3/4" (12 cm)
- BH-016-02 7 1/4" (18.5 cm)
- BH-016-03 8" (20.5 cm)

• **1 x 1 prongs**

- BH-016-04 4 3/4" (12 cm)
- BH-016-05 7 1/4" (18.5 cm)
- BH-016-06 8" (20.5 cm)

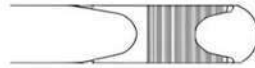
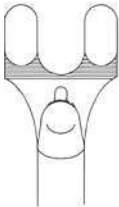

• **Lowman Bone Clamp**

• **2 x 2 prongs on bone clamp**

- BH-017-11 7 1/4" (18.5 cm)
- BH-017-12 8" (20 cm)



- **Lambert-Lowman Bone Holding Clamp**

- 2 x 2 prongs / swivel jaw
- BH-017-S1 7 1/4" (18.5 cm)  
BH-017-S2 8" (20.5 cm)



- **Gersten Traction Bar**

- For Lowman Bone Clamps
- BH-016-G1



• **Ulrich Bone Clamp**

• **Curved to side / With speedlock**

- BH-040-U1 5 1/4" (13.5 cm)
- BH-040-U2 6 1/2" (16.5 cm)
- BH-040-U3\* 7 1/8" (18.25 cm)
- BH-040-U4 9" (23 cm)
- BH-040-U5 10 1/2" (27 cm)

\* = Micro Jaw

• **With speedlock / Straight**

- BH-040-S1 7 1/8" (18.25 cm)
- BH-040-S2\* 7 1/8" (18.25 cm)
- BH-040-S3 9" (23 cm)
- BH-040-S4 10 1/2" (27 cm)



BH-040-S1



BH-040-U1

• **Ulrich Swivel Jaw Bone Clamp**

• **With speed lock / 10 1/2" (27 cm)**

- BH-014-02 straight
- BH-014-01 angled
- BH-014-03 curved to side 1 x 2 prong



BH-014-03



BH-014-02



BH-014-01



# BONE REDUCTION CLAMPS



- **Bone Reduction Clamp Extra Large**

- **Oversized / extra-long ratchet / 12" (30 cm)**

BH-049-E1 extra-long prongs  
BH-049-L1 extra-long shanks

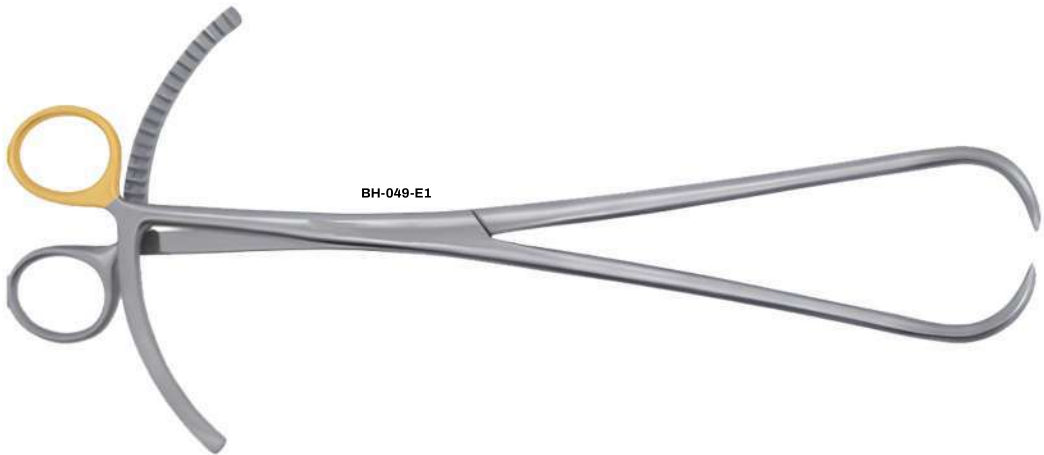
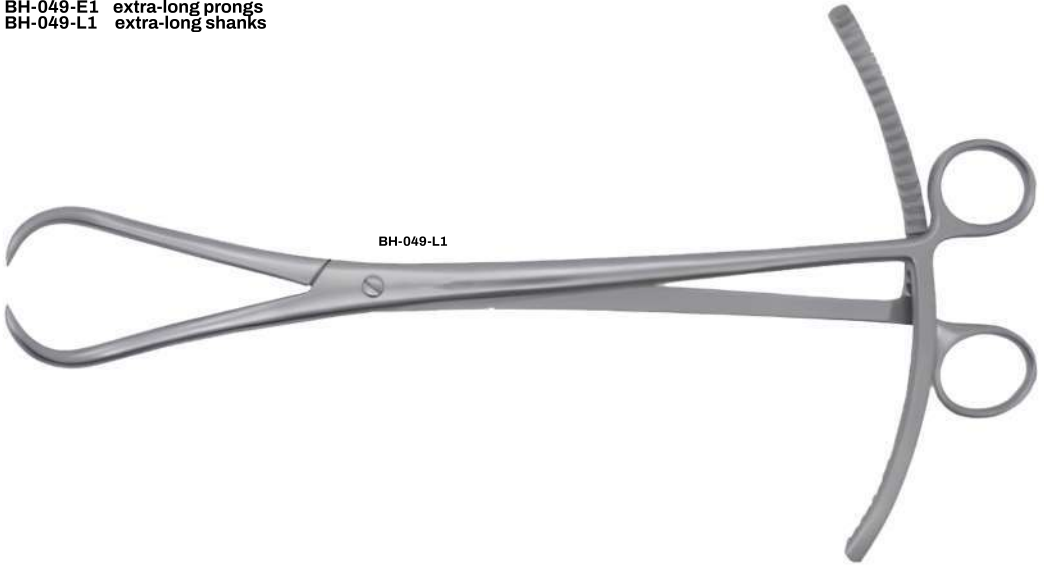

- **AO-Type Bone Reduction Clamp**

- With speedlock / short tips

BH-051-A1 8" (21 cm)

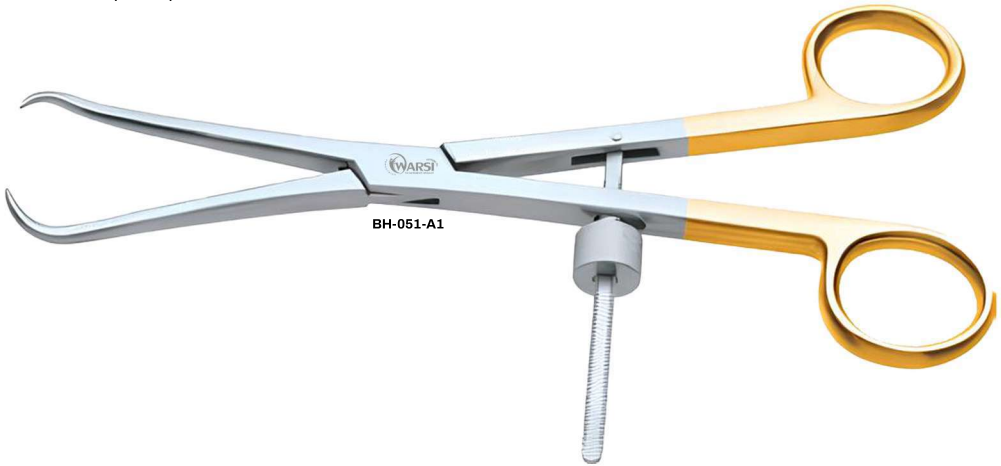

- **Kistler Manus Bone Reduction Clamp**

- With ratchet

BH-033-01 6 1/8" (15 cm)



• **Reil Bone Holding Forceps**

• **Angled /**

BH-020-21 6 3/4" (17.1 cm)

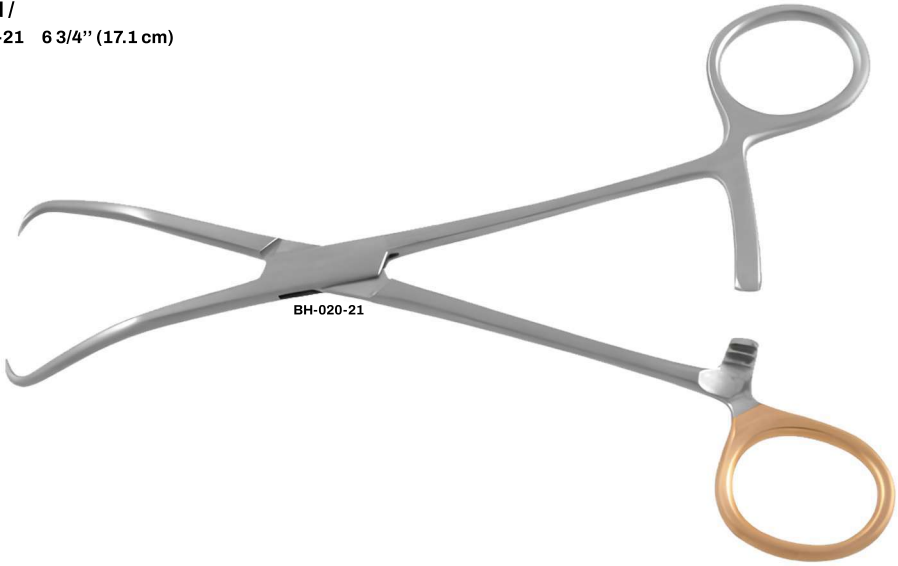

• **Bone Reduction Clamp**

• **With speedlock**

BH-27C-B5 7" (17.8 cm)

BH-27C-B6 8" (20 cm)



• **Bone Reduction Clamp**

• **With ratchet**

- BH-27C-B3\* 6" (15 cm) long double ratchet
- BH-27C-B3N\* 7" (17.8 cm) long double ratchet
- BH-27C-B4 4" (20 cm) extra long ratchet

\*Other sizes available



BH-27C-B3

Standard Angle



BH-27C-B3N

Narrow Angle

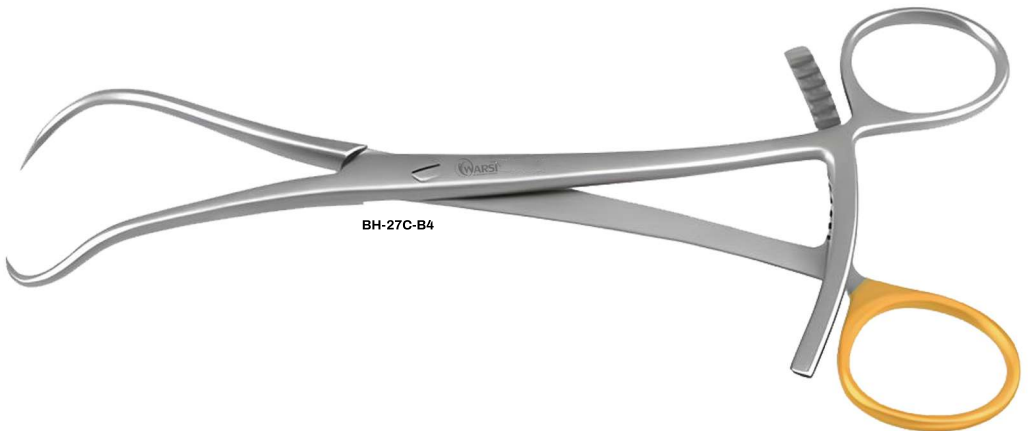

BH-27C-B4

• **Kristler Manus Bone Reduction Clamp**

- With speed lock / serrated jaw/  
BH-015-S2 6 1/8"

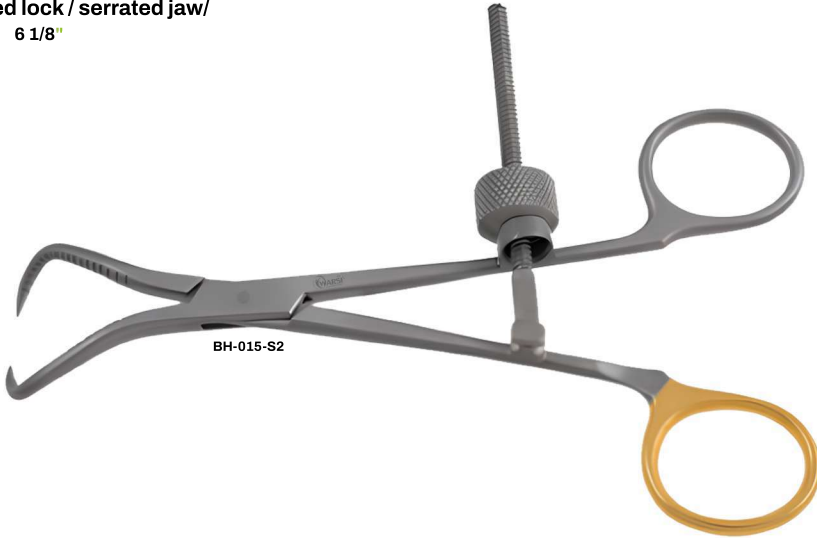

• **Bone Reduction K-Wire Guide Clamp**

- With double long ratchet / with 1.8 mm ID guide cylinder with serrated foot
- BH-1103-W1 with 10 mm k-wire guide 6" (15 cm)  
 BH-1103-W2 with 12 mm k-wire guide 8" (20 cm)  
 BH-1103-W3 with 15 mm k-wire guide 8" (20 cm)



• **Raleigh Bone Reduction Clamp**

- 7 mm / 5 1/2" (14 cm)
- BH-27C-R1 with ratchet
- BH-27C-R2 with speed lock



• **Locke Bone Reduction Clamp**

- With long ratchet / 4 mm / 6" (15.2 cm) BH-027-LR1



• **Locke CSU Bone Reduction Clamp**

• **7 mm / 5 1/2" (14 cm)**

- BH-L21-1 straight with ratchet
- BH-L21-2 curved with ratchet
- BH-S21-1 curved with speedlock
- BH-S21-2 straight with speedlock

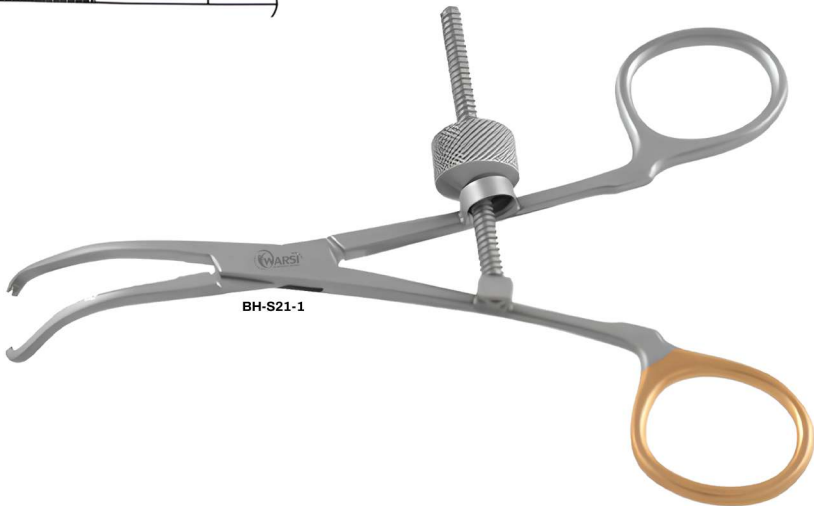
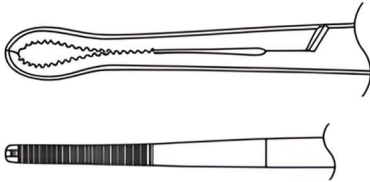
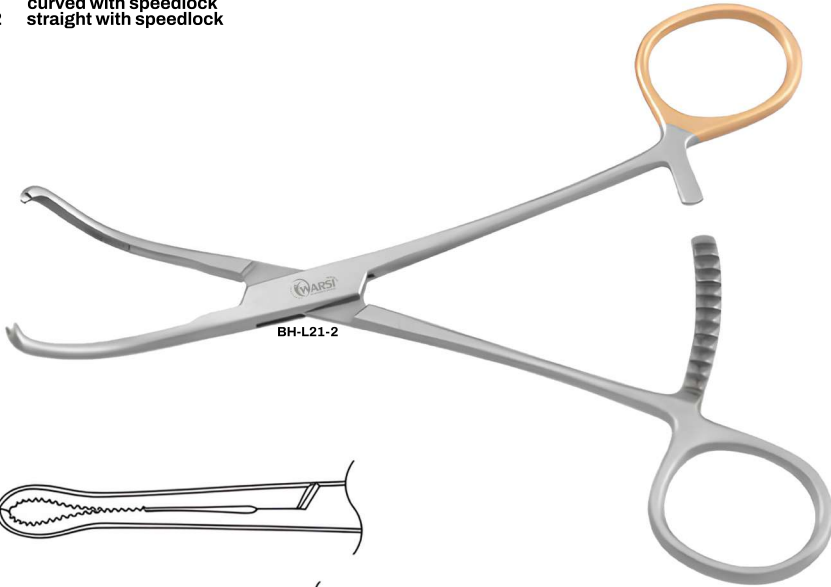

• **Raleigh Bone Holding Forceps**

• **With Ratchet & Speed lock**

- BS-040A 3 mm 5 1/2" with ratchet
- BS-040B 5 mm 5 1/2" with ratchet
- BS-040C 12 mm 7" with speedlock
- BS-040AS 3 mm 5 1/2" with speedlock
- BS-040BS 5 mm 5 1/2" with speedlock

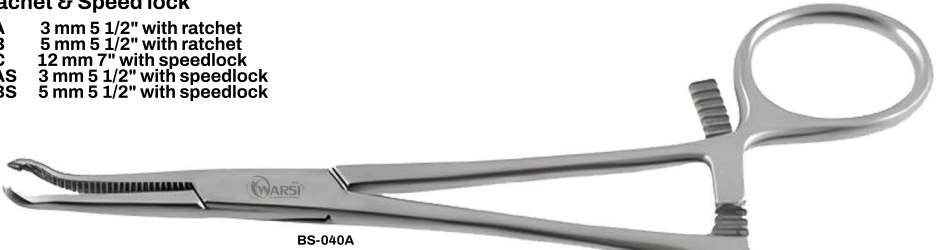

BS-040A



BS-040B

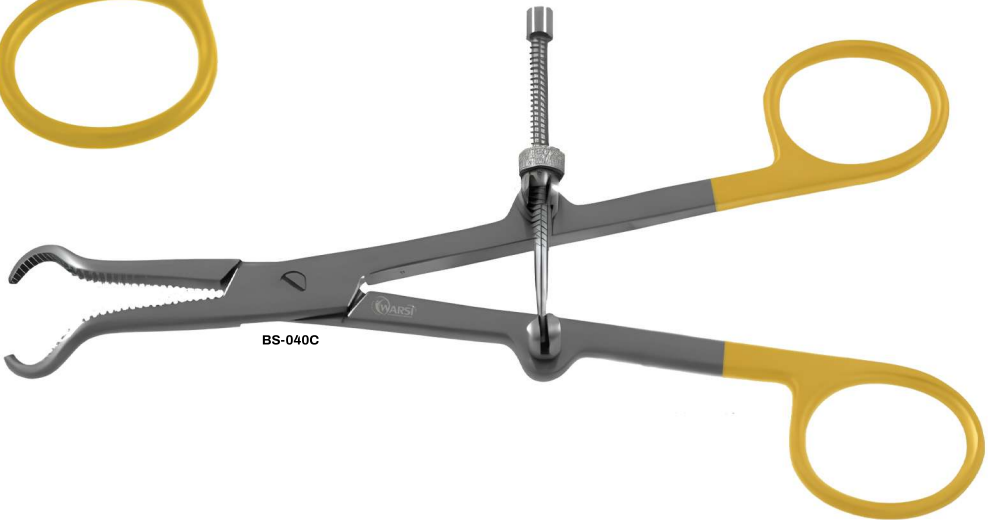

BS-040C

• **Lewin Bone Reduction Clamp**

• **Serrated**

- BH-230-P3 7" (18 cm)
- BH-230-P4M 7 1/2" (19 cm) modified serrations

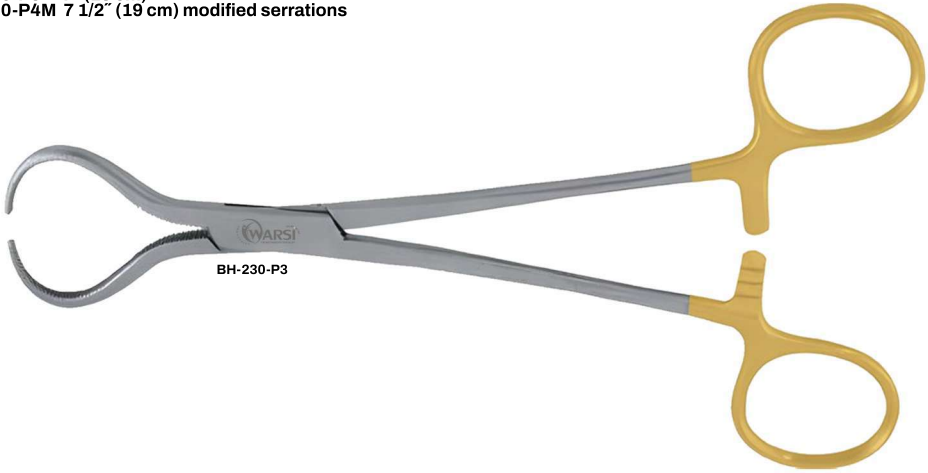

• **Bone Reduction Clamp**

• **With K-wire guide / 5 1/4" (13.5 cm)**

- BH-044-R with ratchet
- BH-044-S with speed lock



• **Bone Holding Forceps**

- With 0.9 mm K-wire guide / curved / 6 3/4" (17.1 cm)  
BH-088-HF with ratchet

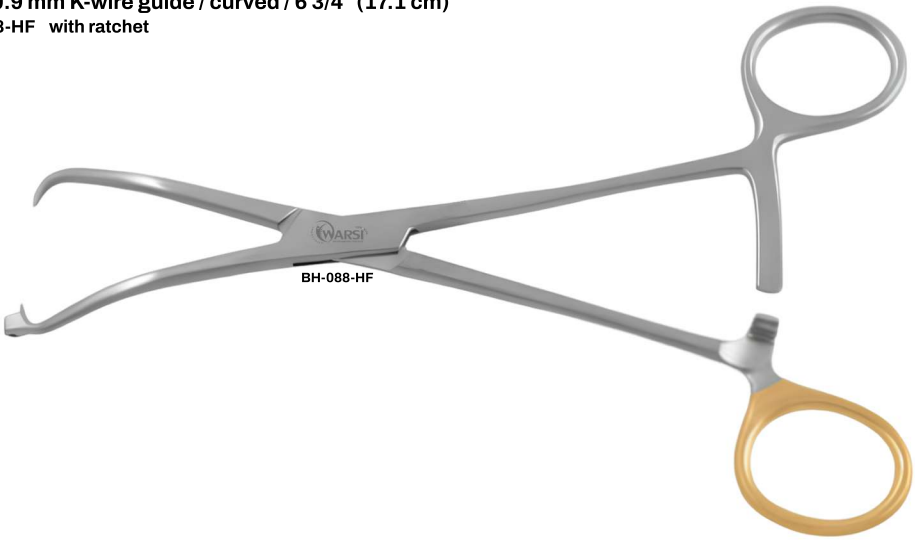

• **Deluxe Bone Reduction Clamp**

- Serrated jaws / with ratchet  
BH-046-SR 5 1/4" (13.3 cm)

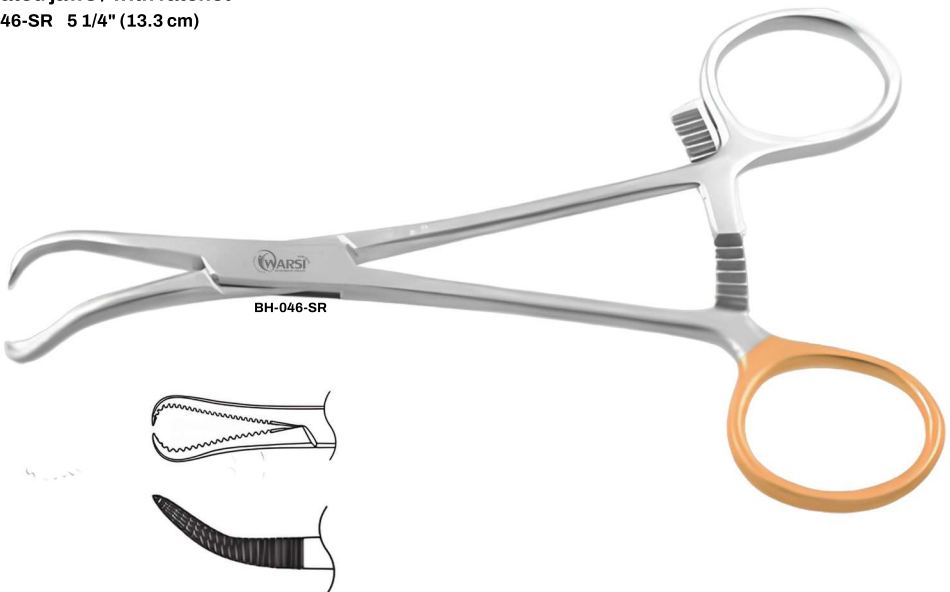

• **Bone Holding Forceps**

• **With extra long ratchet**

- BH-113-40 5 1/8" (13.25 cm)
- BH-113-41 R 5 1/8" (15.2 cm) longer ratchet
- BH-113-42 7" (18 cm)

• **With speedlock**

- BH-113-43 5 1/8" (13.25 cm)
- BH-113-44 6 1/8"
- BH-113-45 6 1/2" (16.5 cm)

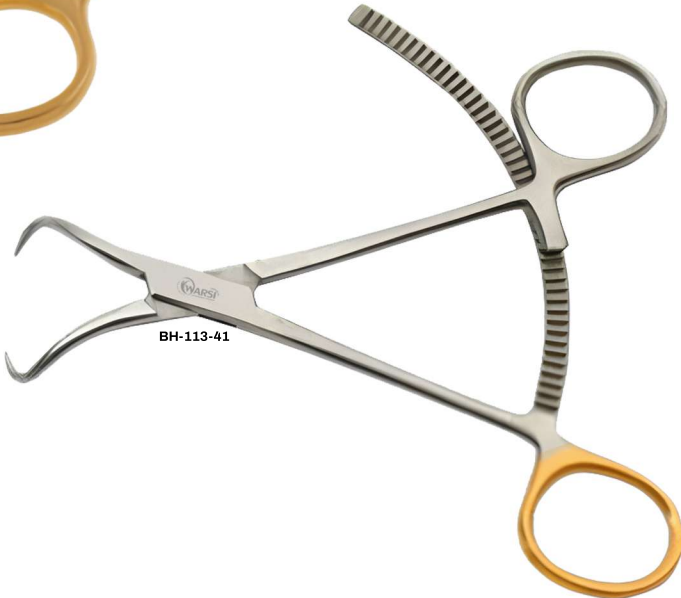

• **Bone Reduction Clamp**

• **AO types**

- BH-103-41A 8" (20.5 cm)
- BH-103-41B 6" (15 cm)
- BH-103-41C 10" (25.5 cm)

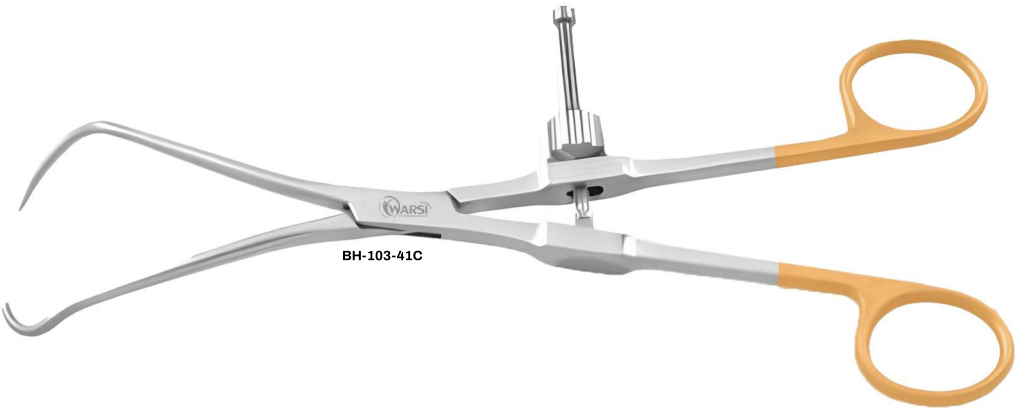
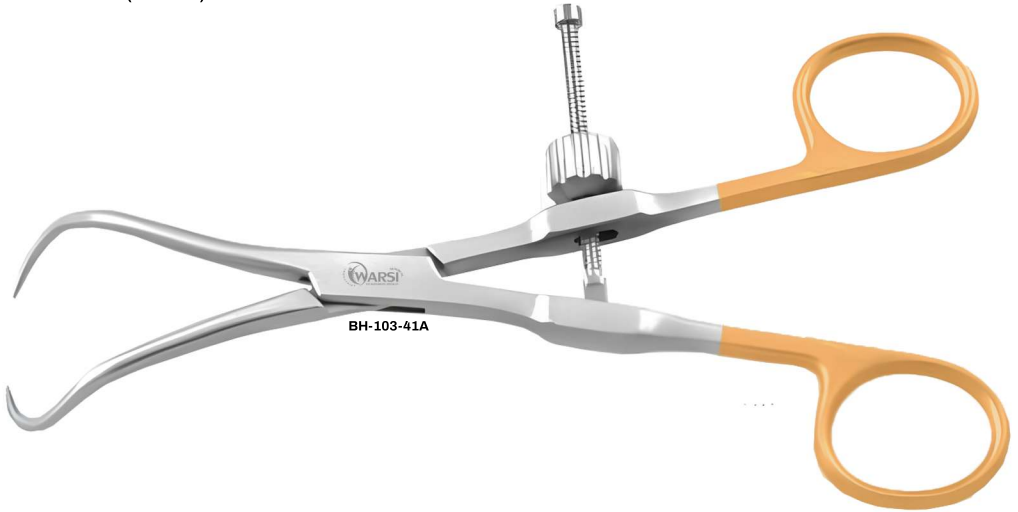

• **Ikuta Bone Clamp**

• **5" (13 cm)**

- BH-05-4A 2.0 mm straight
- BH-05-4B 2.0 mm curved
- BH-05-4C 3.0 mm straight
- BH-05-4D 3.0 mm curved



• **Schroeder Vulsellum Bone Reduction Clamp**

• **9 3/4" (24 cm)**

- BH-055-12 str with speedlock
- BH-056-13 cvd with speedlock
- BH-060-14 str with ratchet
- BH-061-15 cvd up with ratchet
- BH-525-16 cvd sideways with ratchet

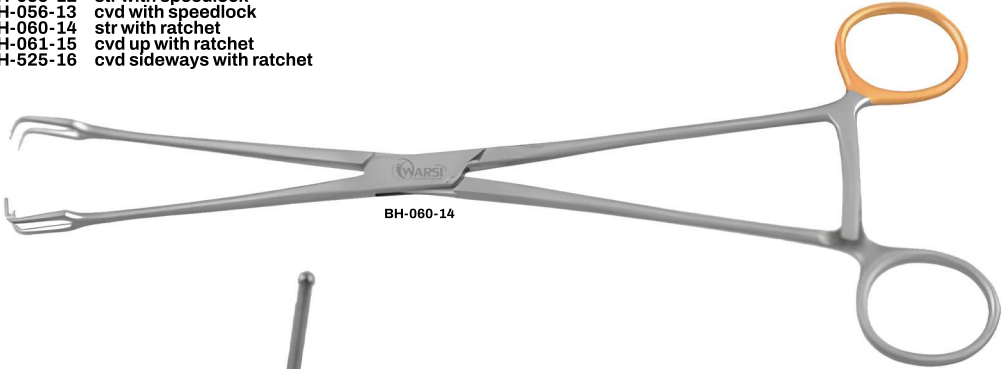

BH-060-14

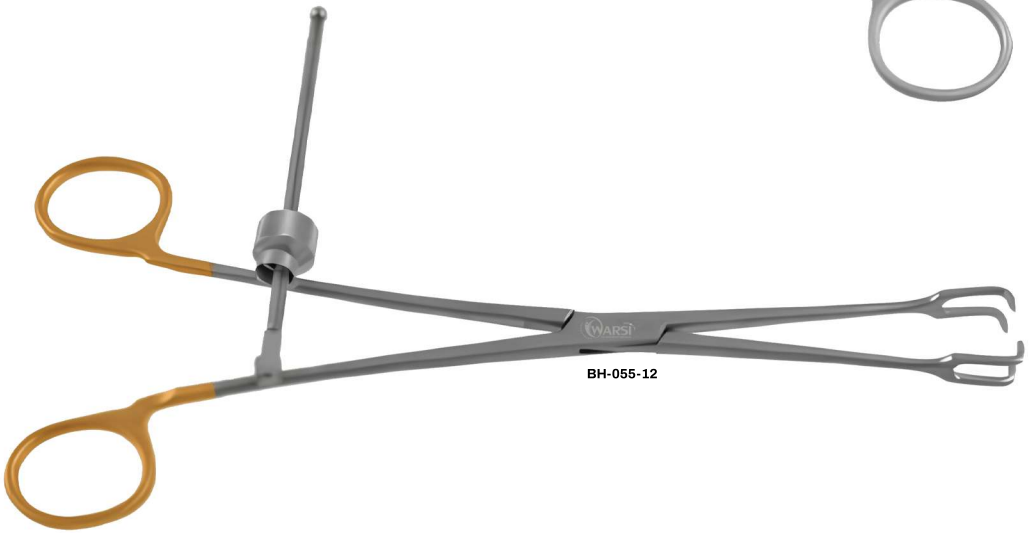

BH-055-12

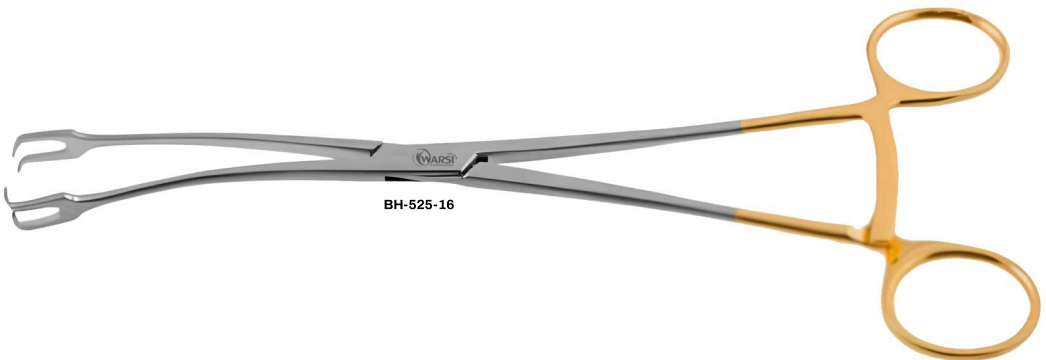

BH-525-16

• **Warsi-Condial Reduction Clamp**

• **8" (20.5 cm)**

BH-036-20 speedlock  
BH-036-20R ratchet



BH-036-20

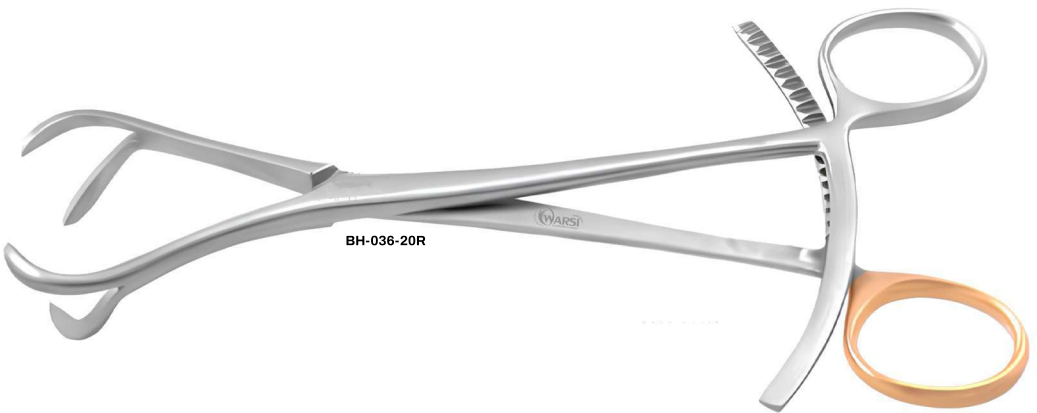

BH-036-20R

• **Micro Bone Reduction Clamp**

- **BH-037-1** 3 3/4" (9.5 cm) with plate holding tip
- **BH-037-A1** 4 3/4" (12 cm)

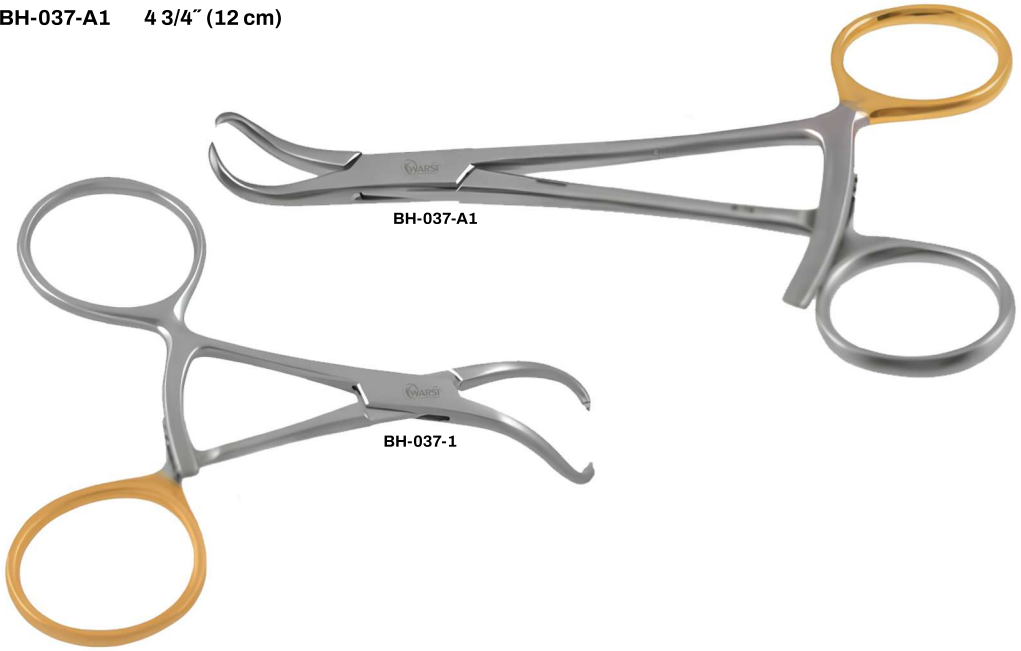

• **Bone Reduction Clamp**

- **With speedlock / 3 3/4" (9.5 cm)**
- **BH-66-037S**



- **Redler Reposition Reduction Clamp**

- With K-wire guide / 1.6 mm / 5 1/4" (13.5 cm)

BH-031-R55



- **Plate & Bone Reduction Forceps**

- With long ratchet / 4 3/4" (12 cm)

BH-038-P3

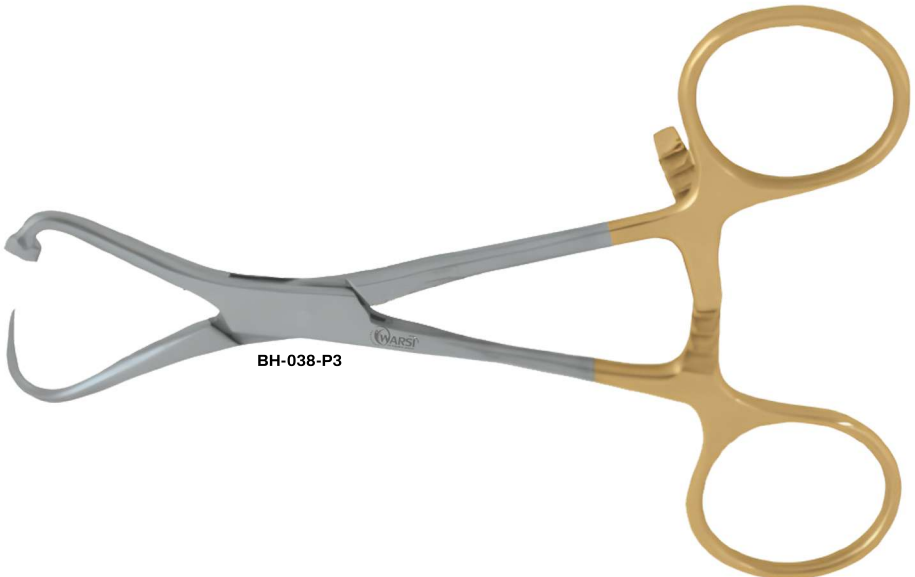

• **Hip Reduction Clamp**

• **With speed lock**

- BH-019-1 7 3/4"
- BH-020-2 10"
- BH-022-3 10" 3 balls spikes
- BH-023-4 10" asymmetric 3 balls spikes
- BH-024-5 10" asymmetric



BH-019-1



BH-022-3



BH-023-4



BH-024-5



# ORTHO CARTILAGE CLAMPS

• **Martin Cartilage Clamp**

- BH-866-1 5 3/4" (14.6 cm)
- BH-867-2 6 1/2" (16.5 cm)
- BH-869-3 7" (18 cm)
- BH-871-4 8" (20 cm)

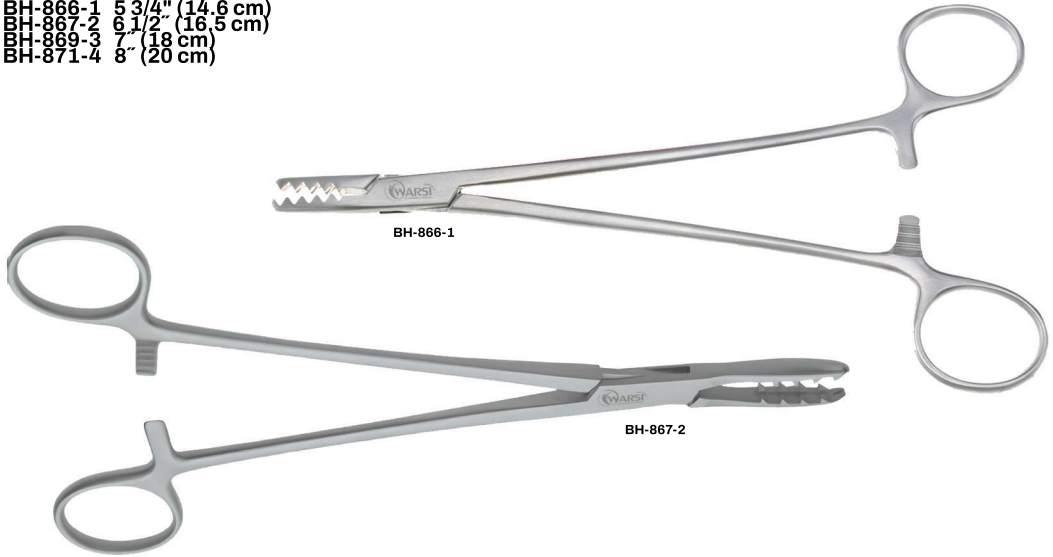

• **Bircher-Ganske Cartilage Clamp**

- 8" (20.5 cm)
- BH-884-1S straight
- BH-885-1C angled



• **CSU Meniscus Clamp**

• 5 3/4" (14.5 cm)

BH-204-1 straight

BH-204-1A angled

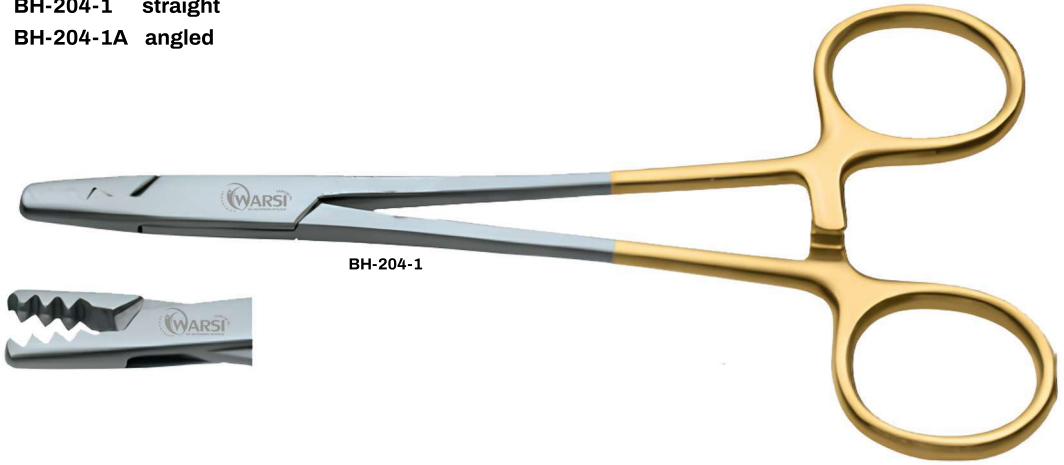

BH-204-1



BH-204-1A

• **Warsi Meniscus Clamp**

- Serrated grooved jaws middle weight / 5 3/8" (13.5 cm)
- BH-202-S1 str
- BH-203-A1 angled

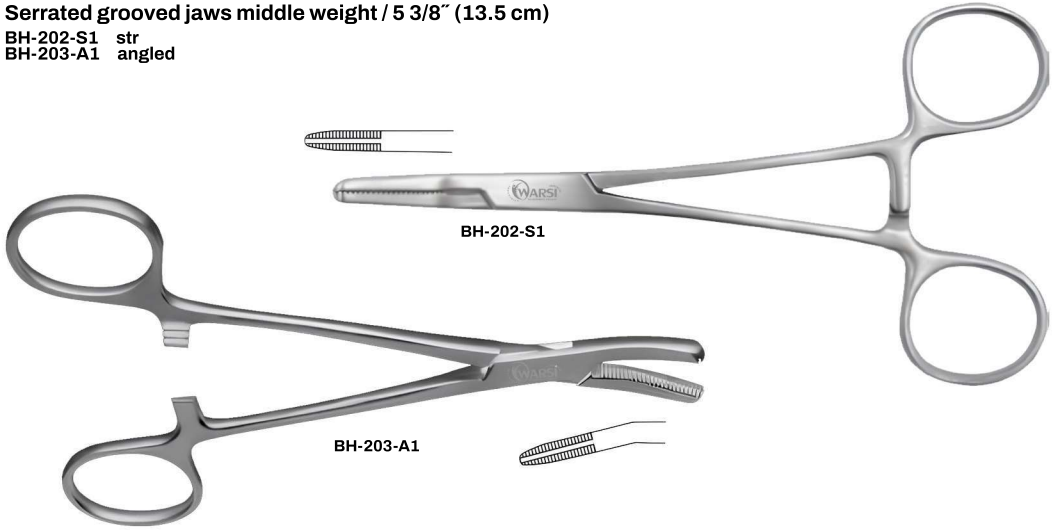

• **Warsi Delicate Meniscus Clamp**

- Heavy serrated jaws with gap / 5 3/8" (13.5 cm)
- BH-202D straight
- BH-203D angled



• **DeBakey Meniscus Clamp**

- Autraumatic jaw / 3 cm jaw / 5 1/2" (14 cm)

BH-199-S1 str  
BH-199-S2 str

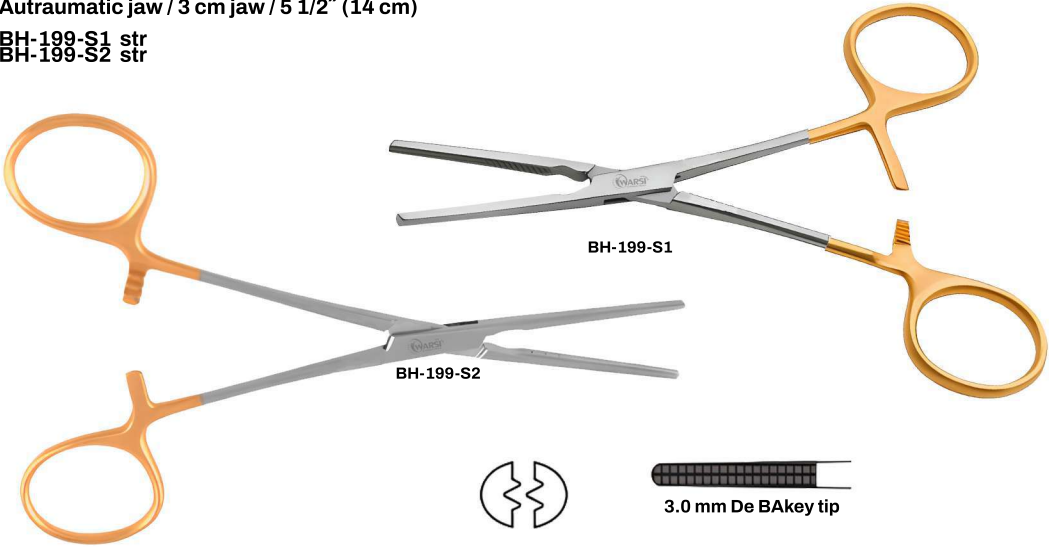

• **Warsi Mesh Meniscus Clamp**

- Fenestrated jaws / 7 1/4" (18.5 cm)

BH-880-T1 15 teeth with 1 x 2  
BH-880-T2

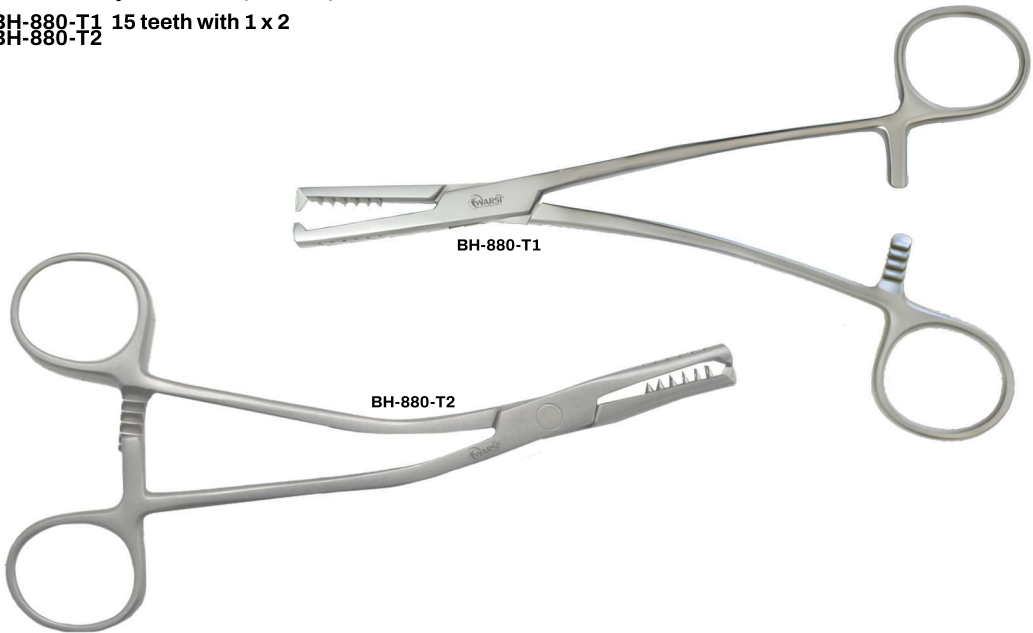

• **DeBakey Mosquito Forceps**

• **6" (15 cm)**

- BH-403-22 straight
- BH-403-23 curved
- BH-403-24 straight

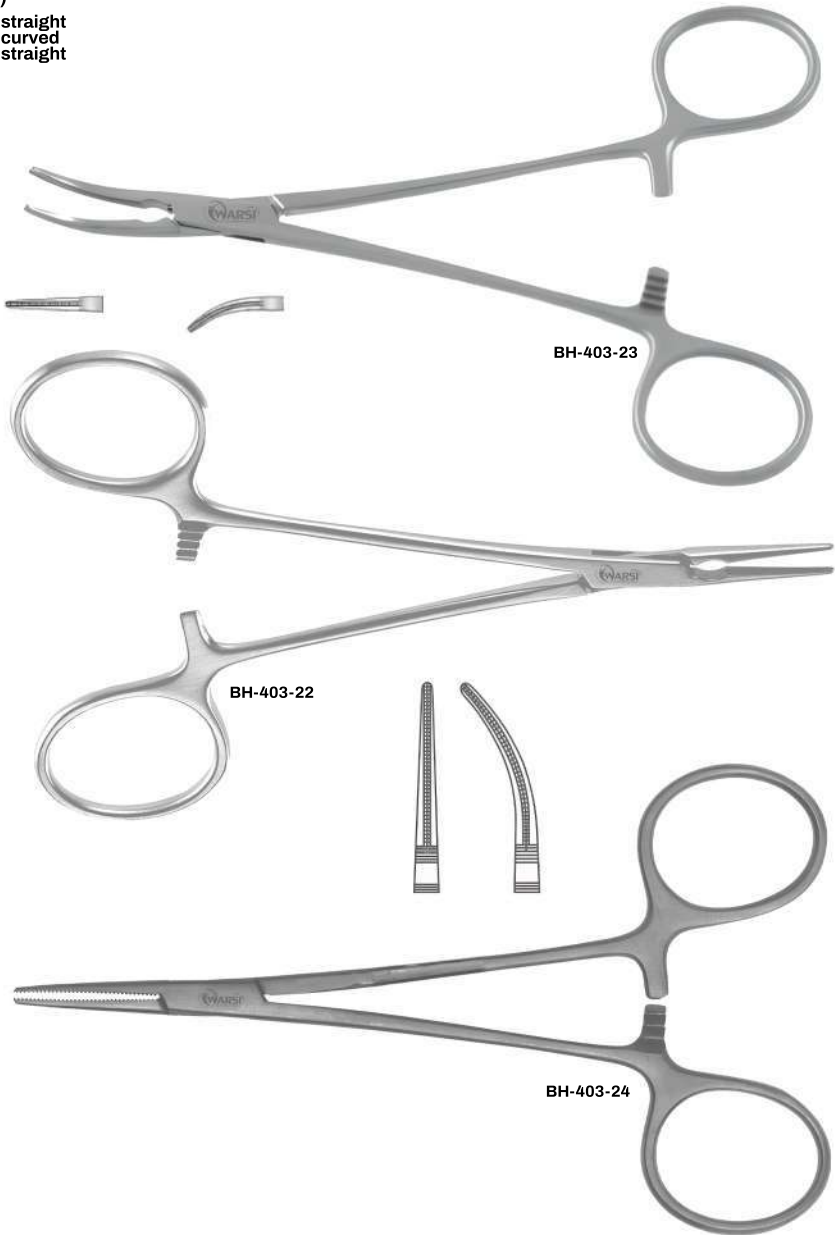

# WARSI SURGICAL INDUSTRIES

---



**Warsi Surgical Industries**  
Bonkan P.O Gohad Pur 51310 Sialkot  
Email: [info@warsisurgical.com](mailto:info@warsisurgical.com)  
Phone/ +92 306 9774076

[www.warsisurgical.com](http://www.warsisurgical.com)